

Applications

HRC fans are designed for transporting clean air. It has many applications in industry, where in technological processes need a small airflow and high pressure. Typical applications:

- supplying air to gas burner systems,
- filtration systems,
- air transport,
- air drying systems,
- cooling systems.

Construction

- high and very high-pressure, direct drive, radial fan,
- steel sheet rotor with backward inclined blades,
- steel welded housing,
- painted RAL 5010 (blue), corrosivity category C3,
- medium maximum temperature 80°C,
- ambient temperature of the motor from -30°C to +60°C (depending on model - see technical characteristic table),
- depending on the motor power, the fans are standard in two figures LG90 and LG270 (see specifications table),
- fans are standard in LG270 configuration.

Electric motor

- asynchronous, three-phase 230V/400V 50Hz or 400/690V 50Hz, efficiency class IE3,
- degree of protection IP55,
- insulation class F,
- three-phase motors are adapted for frequency converter.

Special executions

- optional configuration LG/RD,
- color other than standard and higher category of corrosivity,
- housing and support made of galvanized steel sheet, stainless steel 1.4301, acid-proof steel 1.4404,
- motor with voltage and frequency of power, degree of protection different than standard, equipped with sensors or additional cooling,
- sealing between the housing and the motor,
- HT version - maximum transported medium temperature higher than standard,
- ambient temperature range below -20°C and above +40°C,
- belt drive, clutch,
- ATEX version.

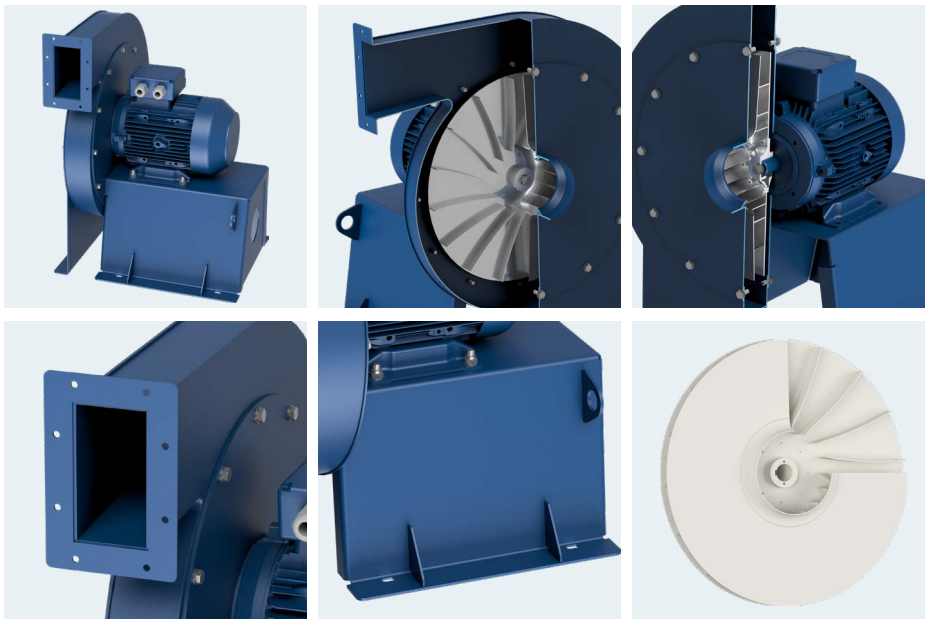

RELATED PRODUCTS

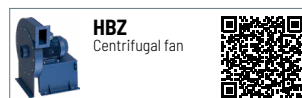
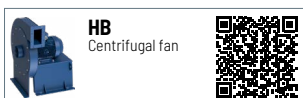



NOMINAL DATA

type	airflow max	pressure max	speed	voltage rated	current max abs.**	power motor	sound pressure level*	temperature operating min / max	temperature ambient min / max	weight	article number
THREE-PHASE 3000RPM											
HRC-2-40-110T	990 m ³ /h	3 300 Pa	2 890 rpm	3~400 V	2,5 A	1,1 kW	68 dB(A)	-30 / 80 °C	-30 / 40 °C	53,0 kg	436044020
HRC-2-40-150T	1 400 m ³ /h	3 300 Pa	2 925 rpm	3~400 V	3,0 A	1,5 kW	65 dB(A)	-30 / 80 °C	-30 / 40 °C	58,0 kg	436044021
HRC-2-40-220T	2 000 m ³ /h	3 300 Pa	2 910 rpm	3~400 V	4,3 A	2,2 kW	68 dB(A)	-30 / 80 °C	-30 / 40 °C	59,0 kg	436044022
HRC-2-45-150T	1 000 m ³ /h	4 150 Pa	2 925 rpm	3~400 V	3,0 A	1,5 kW	74 dB(A)	-30 / 80 °C	-30 / 40 °C	65,0 kg	436044520
HRC-2-45-220T	1 600 m ³ /h	4 150 Pa	2 910 rpm	3~400 V	4,3 A	2,2 kW	71 dB(A)	-30 / 80 °C	-30 / 40 °C	66,0 kg	436044521
HRC-2-45-300T	2 200 m ³ /h	4 150 Pa	2 880 rpm	3~400 V	5,3 A	3,0 kW	68 dB(A)	-30 / 80 °C	-30 / 40 °C	73,0 kg	436044522
HRC-2-45-400T	2 900 m ³ /h	4 150 Pa	2 895 rpm	3~400 V	7,3 A	4,0 kW	72 dB(A)	-30 / 80 °C	-30 / 40 °C	84,0 kg	436044523
HRC-2-50-300T	1 700 m ³ /h	5 150 Pa	2 915 rpm	3~400 V	5,3 A	3,0 kW	75 dB(A)	-30 / 80 °C	-30 / 40 °C	81,0 kg	436045020
HRC-2-50-400T	2 350 m ³ /h	5 150 Pa	2 895 rpm	3~400 V	7,3 A	4,0 kW	74 dB(A)	-30 / 80 °C	-30 / 40 °C	92,0 kg	436045021
HRC-2-50-550T	3 300 m ³ /h	5 150 Pa	2 940 rpm	3~400 V	10 A	5,5 kW	71 dB(A)	-30 / 80 °C	-30 / 40 °C	111,0 kg	436045022
HRC-2-50-750T	4 000 m ³ /h	5 150 Pa	2 930 rpm	3~400 V	13,3 A	7,5 kW	74 dB(A)	-30 / 80 °C	-30 / 40 °C	130,0 kg	436045023
HRC-2-56-550T	2 400 m ³ /h	6 470 Pa	2 940 rpm	3~400 V	10 A	5,5 kW	80 dB(A)	-30 / 80 °C	-30 / 40 °C	123,0 kg	436045620
HRC-2-56-750T	3 600 m ³ /h	6 470 Pa	2 930 rpm	3~400 V	13,3 A	7,5 kW	76 dB(A)	-30 / 80 °C	-30 / 40 °C	132,0 kg	436045621
HRC-2-56-1100T	5 180 m ³ /h	6 470 Pa	2 925 rpm	3~400 V	19,3 A	11 kW	77 dB(A)	-30 / 80 °C	-30 / 40 °C	191,0 kg	436045622
HRC-2-56-1500T	6 020 m ³ /h	6 470 Pa	2 940 rpm	3~400 V	26 A	15 kW	79 dB(A)	-30 / 80 °C	-30 / 40 °C	200,0 kg	436045623
HRC-2-63-750T	2 450 m ³ /h	8 190 Pa	2 930 rpm	3~400 V	13,3 A	7,5 kW	84 dB(A)	-30 / 80 °C	-30 / 40 °C	153,0 kg	436046320
HRC-2-63-1100T	3 900 m ³ /h	8 190 Pa	2 925 rpm	3~400 V	19,3 A	11 kW	82 dB(A)	-30 / 80 °C	-30 / 40 °C	212,0 kg	436046321
HRC-2-63-1500T	5 800 m ³ /h	8 190 Pa	2 940 rpm	3~400 V	26 A	15 kW	79 dB(A)	-30 / 80 °C	-30 / 40 °C	221,0 kg	436046322
HRC-2-63-1850T	6 950 m ³ /h	8 190 Pa	2 940 rpm	3~400 V	32,1 A	18,5 kW	80 dB(A)	-30 / 80 °C	-30 / 40 °C	228,0 kg	436046323
HRC-2-63-2200T	7 900 m ³ /h	8 190 Pa	2 950 rpm	3~400 V	38,1 A	22 kW	80 dB(A)	-30 / 80 °C	-30 / 40 °C	279,0 kg	436046324
HRC-2-71-1500T	4 000 m ³ /h	10 400 Pa	2 940 rpm	3~400 V	26 A	15 kW	91 dB(A)	-30 / 80 °C	-30 / 40 °C	244,0 kg	436047120
HRC-2-71-1850T	5 400 m ³ /h	10 400 Pa	2 940 rpm	3~400 V	32 A	18,5 kW	86 dB(A)	-30 / 80 °C	-30 / 40 °C	251,0 kg	436047121
HRC-2-71-2200T	6 600 m ³ /h	10 400 Pa	2 950 rpm	3~400 V	38,1 A	22 kW	83 dB(A)	-30 / 80 °C	-30 / 40 °C	302,0 kg	436047122
HRC-2-71-3000T	8 900 m ³ /h	10 400 Pa	2 965 rpm	3~400 V	53 A	30 kW	82 dB(A)	-30 / 80 °C	-30 / 40 °C	370,0 kg	436047123
HRC-2-71-3700T	10 850 m ³ /h	10 400 Pa	2 955 rpm	3~400 V	65 A	37 kW	84 dB(A)	-30 / 80 °C	-30 / 40 °C	385,0 kg	436047124
HRC-2-80-3000T	6 400 m ³ /h	13 200 Pa	2 965 rpm	3~400 V	53 A	30 kW	92 dB(A)	-30 / 80 °C	-30 / 40 °C	395,0 kg	436048020
HRC-2-80-3700T	8 300 m ³ /h	13 200 Pa	2 955 rpm	3~400 V	65 A	37 kW	89 dB(A)	-30 / 80 °C	-30 / 40 °C	410,0 kg	436048021
HRC-2-80-4500T	10 400 m ³ /h	13 200 Pa	2 960 rpm	3~400 V	77 A	45 kW	86 dB(A)	-30 / 80 °C	-30 / 40 °C	525,0 kg	436048022
HRC-2-80-5500T	13 000 m ³ /h	13 200 Pa	2 970 rpm	3~400 V	92 A	55 kW	87 dB(A)	-30 / 80 °C	-30 / 40 °C	560,0 kg	436048023
HRC-2-80-7500T	16 290 m ³ /h	13 200 Pa	2 960 rpm	3~400 V	127 A	75 kW	90 dB(A)	-30 / 80 °C	-30 / 40 °C	710,0 kg	436048024
HRC-2-90-5500T	10 000 m ³ /h	16 700 Pa	2 970 rpm	3~400 V	92 A	55 kW	94 dB(A)	-30 / 80 °C	-30 / 40 °C	611,0 kg	436049020
HRC-2-90-7500T	13 600 m ³ /h	16 700 Pa	2 960 rpm	3~400 V	127 A	75 kW	92 dB(A)	-30 / 80 °C	-30 / 40 °C	761,0 kg	436049021
HRC-2-90-9000T	17 100 m ³ /h	16 700 Pa	2 980 rpm	3~400 V	150 A	90 kW	89 dB(A)	-30 / 80 °C	-30 / 40 °C	851,0 kg	436049022
HRC-2-90-11000T	20 250 m ³ /h	16 700 Pa	2 980 rpm	3~400 V	183 A	110 kW	91 dB(A)	-30 / 80 °C	-30 / 40 °C	995,0 kg	436049023
HRC-2-90-13200T	23 150 m ³ /h	16 700 Pa	2 975 rpm	3~400 V	222 A	132 kW	92 dB(A)	-30 / 80 °C	-30 / 40 °C	1 168,0 kg	436049024
HRC-2-100-7500T	9 400 m ³ /h	21 150 Pa	2 960 rpm	3~400 V	127 A	75 kW	99 dB(A)	-30 / 80 °C	-30 / 40 °C	789,0 kg	436041020
HRC-2-100-9000T	12 000 m ³ /h	21 150 Pa	2 980 rpm	3~400 V	150 A	90 kW	99 dB(A)	-30 / 80 °C	-30 / 40 °C	879,0 kg	436041021
HRC-2-100-11000T	15 200 m ³ /h	21 150 Pa	2 980 rpm	3~400 V	183 A	110 kW	97 dB(A)	-30 / 80 °C	-30 / 40 °C	1 023,0 kg	436041022
HRC-2-100-13200T	19 200 m ³ /h	21 150 Pa	2 975 rpm	3~400 V	222 A	132 kW	95 dB(A)	-30 / 80 °C	-30 / 40 °C	1 196,0 kg	436041023
HRC-2-100-16000T	22 000 m ³ /h	21 150 Pa	2 978 rpm	3~400 V	262 A	160 kW	94 dB(A)	-30 / 80 °C	-30 / 40 °C	1 344,0 kg	436041024
HRC-2-100-20000T	28 150 m ³ /h	21 150 Pa	2 980 rpm	3~400 V	324 A	200 kW	93 dB(A)	-30 / 80 °C	-30 / 40 °C	1 411,0 kg	436041025

*Measurement made at a distance of 1.5m from the outlet, for Q = 2/3 * Qmax
 ** value of the rated current may vary depending on the manufacturer of the electric motor used.



NOMINAL DATA

type	airflow max	pressure max	speed	voltage rated	current max abs.**	power motor	sound pressure level*	temperature operating min / max	temperature ambient min / max	weight	article number
THREE-PHASE 1500RPM											
HRC-4-40-012T	400 m ³ /h	790 Pa	1380 rpm	3~400 V	0,45 A	0,12 kW	54 dB(A)	-30 / 80 °C	-30 / 40 °C	45,0 kg	436044040
HRC-4-40-018T	690 m ³ /h	790 Pa	1380 rpm	3~400 V	0,65 A	0,18 kW	52 dB(A)	-30 / 80 °C	-30 / 40 °C	45,0 kg	436044041
HRC-4-40-025T	950 m ³ /h	790 Pa	1380 rpm	3~400 V	0,85 A	0,25 kW	51 dB(A)	-30 / 80 °C	-15 / 40 °C	46,0 kg	436044042
HRC-4-45-025T	630 m ³ /h	1000 Pa	1380 rpm	3~400 V	0,86 A	0,25 kW	58 dB(A)	-30 / 80 °C	-15 / 40 °C	53,0 kg	436044540
HRC-4-45-037T	1120 m ³ /h	1000 Pa	1370 rpm	3~400 V	1,15 A	0,37 kW	54 dB(A)	-30 / 80 °C	-15 / 40 °C	54,0 kg	436044541
HRC-4-45-055T	1420 m ³ /h	1000 Pa	1400 rpm	3~400 V	1,7 A	0,55 kW	57 dB(A)	-30 / 80 °C	-30 / 40 °C	55,0 kg	436044542
HRC-4-50-037T	900 m ³ /h	1240 Pa	1370 rpm	3~400 V	1,15 A	0,37 kW	61 dB(A)	-30 / 80 °C	-30 / 40 °C	62,0 kg	436045040
HRC-4-50-055T	1400 m ³ /h	1240 Pa	1400 rpm	3~400 V	1,7 A	0,55 kW	56 dB(A)	-30 / 80 °C	-30 / 40 °C	63,0 kg	436045041
HRC-4-50-075T	1750 m ³ /h	1240 Pa	1430 rpm	3~400 V	2,1 A	0,75 kW	58 dB(A)	-30 / 80 °C	-15 / 40 °C	67,0 kg	436045042
HRC-4-50-110T	1940 m ³ /h	1240 Pa	1430 rpm	3~400 V	2,5 A	1,1 kW	59 dB(A)	-30 / 80 °C	-15 / 40 °C	74,0 kg	436045043
HRC-4-56-075T	1420 m ³ /h	1560 Pa	1430 rpm	3~400 V	2,1 A	0,75 kW	62 dB(A)	-30 / 80 °C	-15 / 40 °C	79,0 kg	436045640
HRC-4-56-110T	2200 m ³ /h	1560 Pa	1430 rpm	3~400 V	2,5 A	1,1 kW	60 dB(A)	-30 / 80 °C	-30 / 40 °C	86,0 kg	436045641
HRC-4-56-150T	2700 m ³ /h	1560 Pa	1440 rpm	3~400 V	3,6 A	1,5 kW	63 dB(A)	-30 / 80 °C	-30 / 40 °C	96,0 kg	436045642
HRC-4-56-220T	2990 m ³ /h	1560 Pa	1465 rpm	3~400 V	4,6 A	2,2 kW	64 dB(A)	-30 / 80 °C	-30 / 40 °C	96,0 kg	436045643
HRC-4-63-110T	1700 m ³ /h	1970 Pa	1430 rpm	3~400 V	2,5 A	1,10 kW	68 dB(A)	-30 / 80 °C	-30 / 40 °C	107,0 kg	436046340
HRC-4-63-150T	2300 m ³ /h	1970 Pa	1440 rpm	3~400 V	3,6 A	1,5 kW	65 dB(A)	-30 / 80 °C	-15 / 40 °C	117,0 kg	436046341
HRC-4-63-220T	3430 m ³ /h	1970 Pa	1465 rpm	3~400 V	4,6 A	2,2 kW	64 dB(A)	-30 / 80 °C	-15 / 40 °C	117,0 kg	436046342
HRC-4-63-300T	3900 m ³ /h	1970 Pa	1460 rpm	3~400 V	6,7 A	3,0 kW	67 dB(A)	-30 / 80 °C	-30 / 60 °C	120,0 kg	436046343
HRC-4-71-220T	2580 m ³ /h	2500 Pa	1465 rpm	3~400 V	4,6 A	2,2 kW	71 dB(A)	-30 / 80 °C	-30 / 40 °C	138,0 kg	436047140
HRC-4-71-300T	3600 m ³ /h	2500 Pa	1460 rpm	3~400 V	6,7 A	3,0 kW	68 dB(A)	-30 / 80 °C	-30 / 40 °C	141,0 kg	436047141
HRC-4-71-400T	4900 m ³ /h	2500 Pa	1460 rpm	3~400 V	8,1 A	4,0 kW	68 dB(A)	-30 / 80 °C	-30 / 40 °C	152,0 kg	436047142
HRC-4-71-550T	5600 m ³ /h	2500 Pa	1460 rpm	3~400 V	10,9 A	5,5 kW	69 dB(A)	-30 / 80 °C	-15 / 40 °C	173,0 kg	436047143
HRC-4-80-300T	2620 m ³ /h	3190 Pa	1460 rpm	3~400 V	6,7 A	3,0 kW	76 dB(A)	-30 / 80 °C	-30 / 60 °C	165,0 kg	436048040
HRC-4-80-400T	3800 m ³ /h	3190 Pa	1460 rpm	3~400 V	8,1 A	4,0 kW	75 dB(A)	-30 / 80 °C	-30 / 60 °C	176,0 kg	436048041
HRC-4-80-550T	5370 m ³ /h	3190 Pa	1460 rpm	3~400 V	10,9 A	5,5 kW	72 dB(A)	-30 / 80 °C	-30 / 60 °C	197,0 kg	436048042
HRC-4-80-750T	7200 m ³ /h	3190 Pa	1465 rpm	3~400 V	14,4 A	7,5 kW	72 dB(A)	-30 / 80 °C	-30 / 40 °C	201,0 kg	436048043
HRC-4-80-1100T	8000 m ³ /h	3190 Pa	1475 rpm	3~400 V	20,9 A	11 kW	74 dB(A)	-30 / 80 °C	-30 / 40 °C	270,0 kg	436048044
HRC-4-90-550T	3700 m ³ /h	4000 Pa	1460 rpm	3~400 V	10,9 A	5,5 kW	80 dB(A)	-30 / 80 °C	-30 / 40 °C	247,0 kg	436049040
HRC-4-90-750T	5500 m ³ /h	4000 Pa	1465 rpm	3~400 V	14,4 A	7,5 kW	78 dB(A)	-30 / 80 °C	-30 / 60 °C	251,0 kg	436049041
HRC-4-90-1100T	7700 m ³ /h	4000 Pa	1475 rpm	3~400 V	20,9 A	11 kW	76 dB(A)	-30 / 80 °C	-30 / 60 °C	320,0 kg	436049042
HRC-4-90-1500T	11450 m ³ /h	4000 Pa	1475 rpm	3~400 V	28,1 A	15 kW	77 dB(A)	-30 / 80 °C	-30 / 40 °C	348,0 kg	436049043
HRC-4-100-1100T	6500 m ³ /h	5100 Pa	1475 rpm	3~400 V	20,9 A	11 kW	84 dB(A)	-30 / 80 °C	-30 / 40 °C	348,0 kg	436041040
HRC-4-100-1500T	9250 m ³ /h	5100 Pa	1475 rpm	3~400 V	28,1 A	15 kW	80 dB(A)	-30 / 80 °C	-30 / 40 °C	366,0 kg	436041041
HRC-4-100-1850T	11100 m ³ /h	5100 Pa	1475 rpm	3~400 V	33,9 A	18,5 kW	77 dB(A)	-30 / 80 °C	-30 / 40 °C	402,0 kg	436041042
HRC-4-100-2200T	13200 m ³ /h	5100 Pa	1475 rpm	3~400 V	41,1 A	22 kW	78 dB(A)	-30 / 80 °C	-30 / 60 °C	412,0 kg	436041043
HRC-4-100-3000T	16000 m ³ /h	5100 Pa	1477 rpm	3~400 V	52 A	30 kW	81 dB(A)	-30 / 80 °C	-30 / 40 °C	541,0 kg	436041044

*Measurement made at a distance of 1.5m from the outlet, for Q = 2/3 * Qmax

** value of the rated current may vary depending on the manufacturer of the electric motor used.



PERFORMANCE CHARACTERISTICS OF THE FANS - THREE-PHASE 3000RPM 40-56

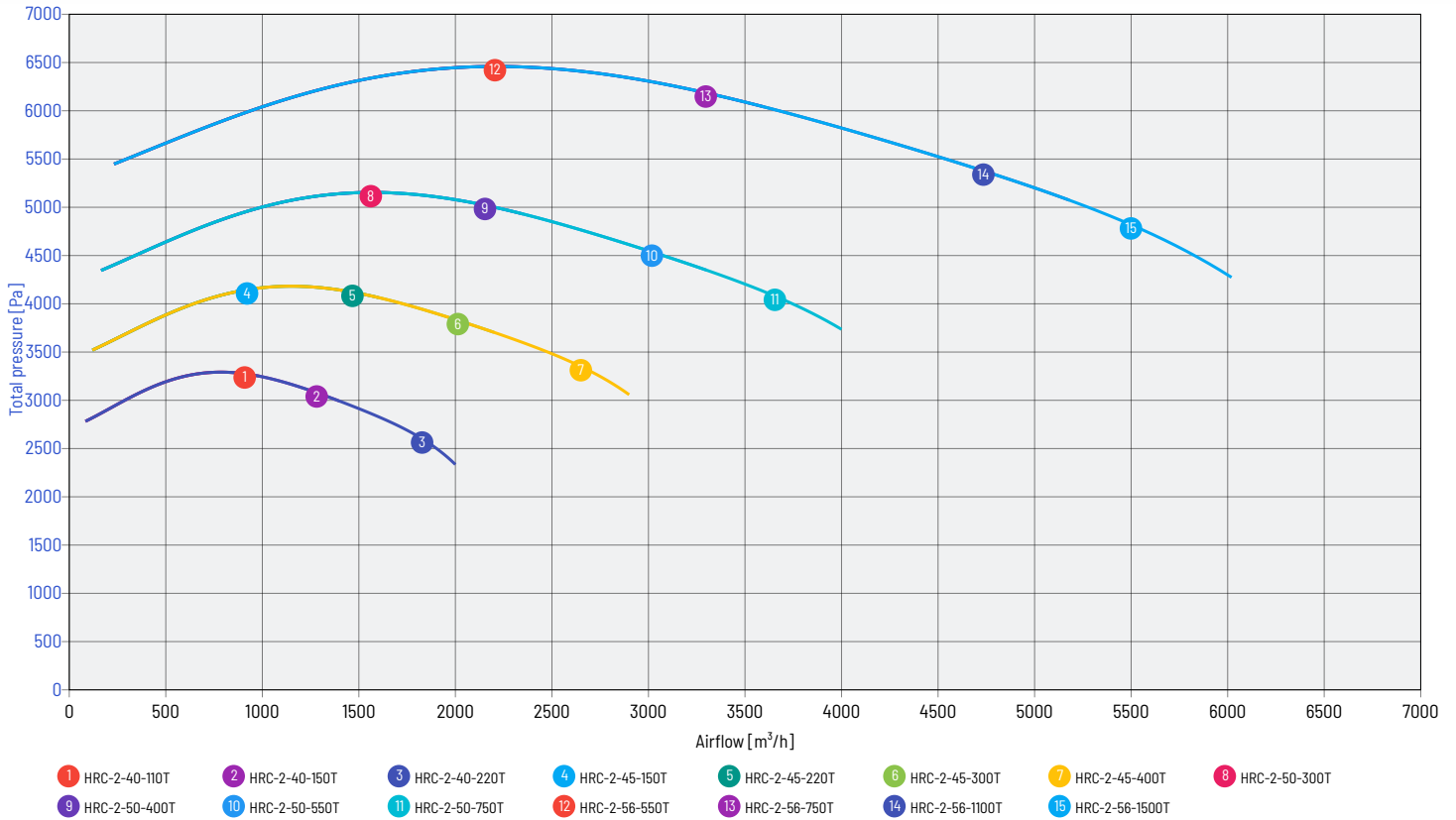

PERFORMANCE CHARACTERISTICS OF THE FANS - THREE-PHASE 3000RPM 63-100

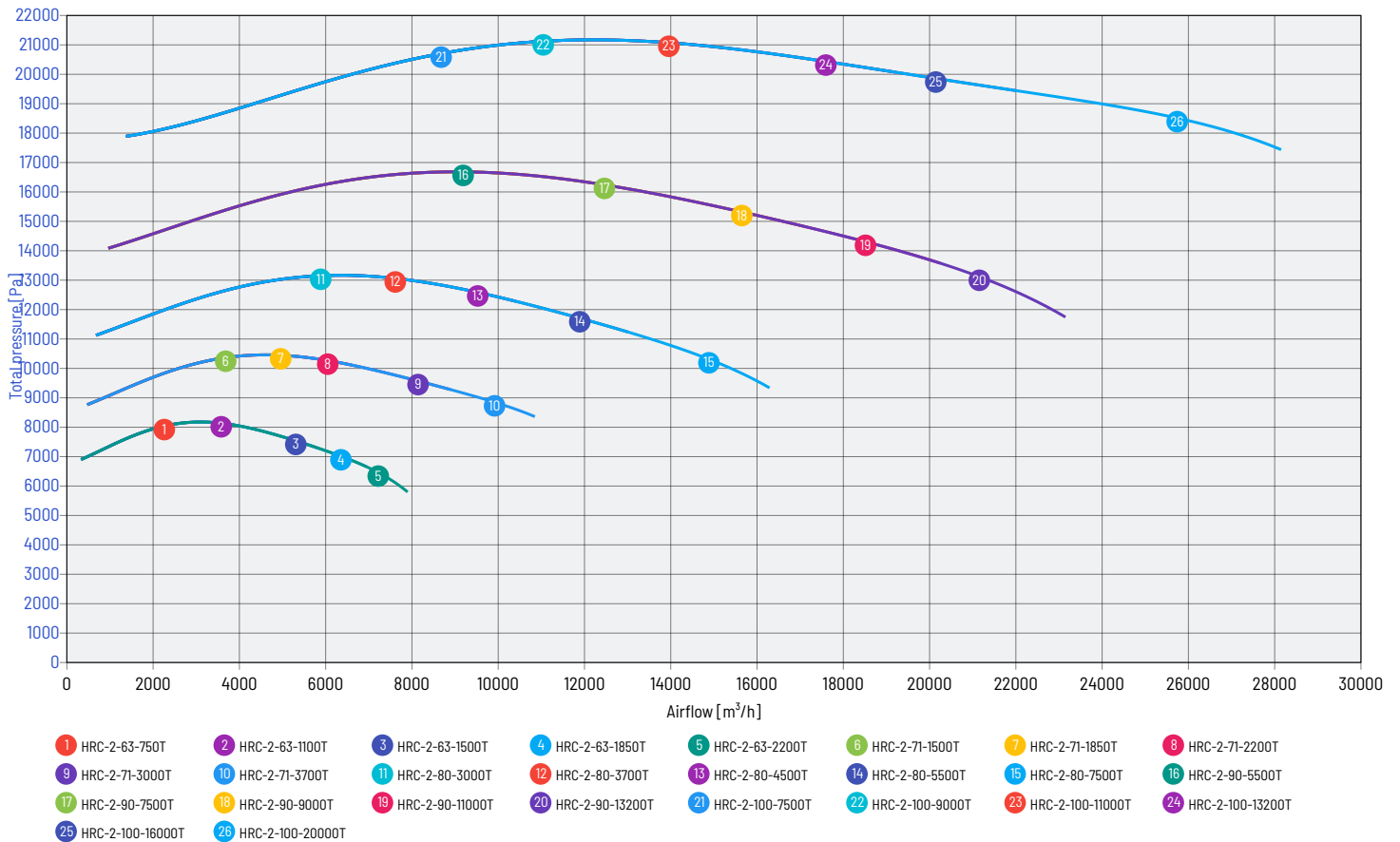



PERFORMANCE CHARACTERISTICS OF THE FANS - THREE-PHASE 1500RPM 40-56

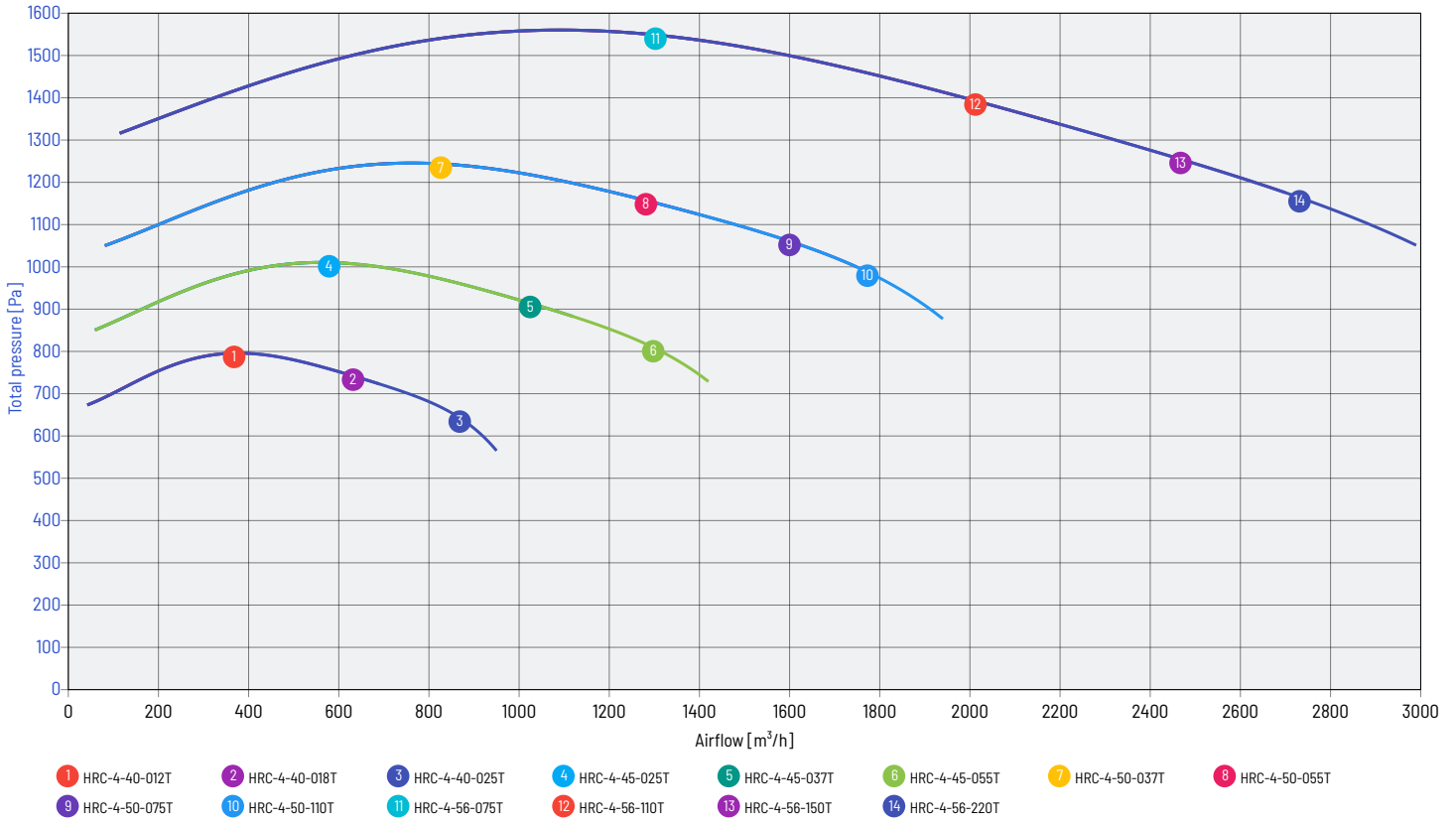

PERFORMANCE CHARACTERISTICS OF THE FANS - THREE-PHASE 1500RPM 63-100

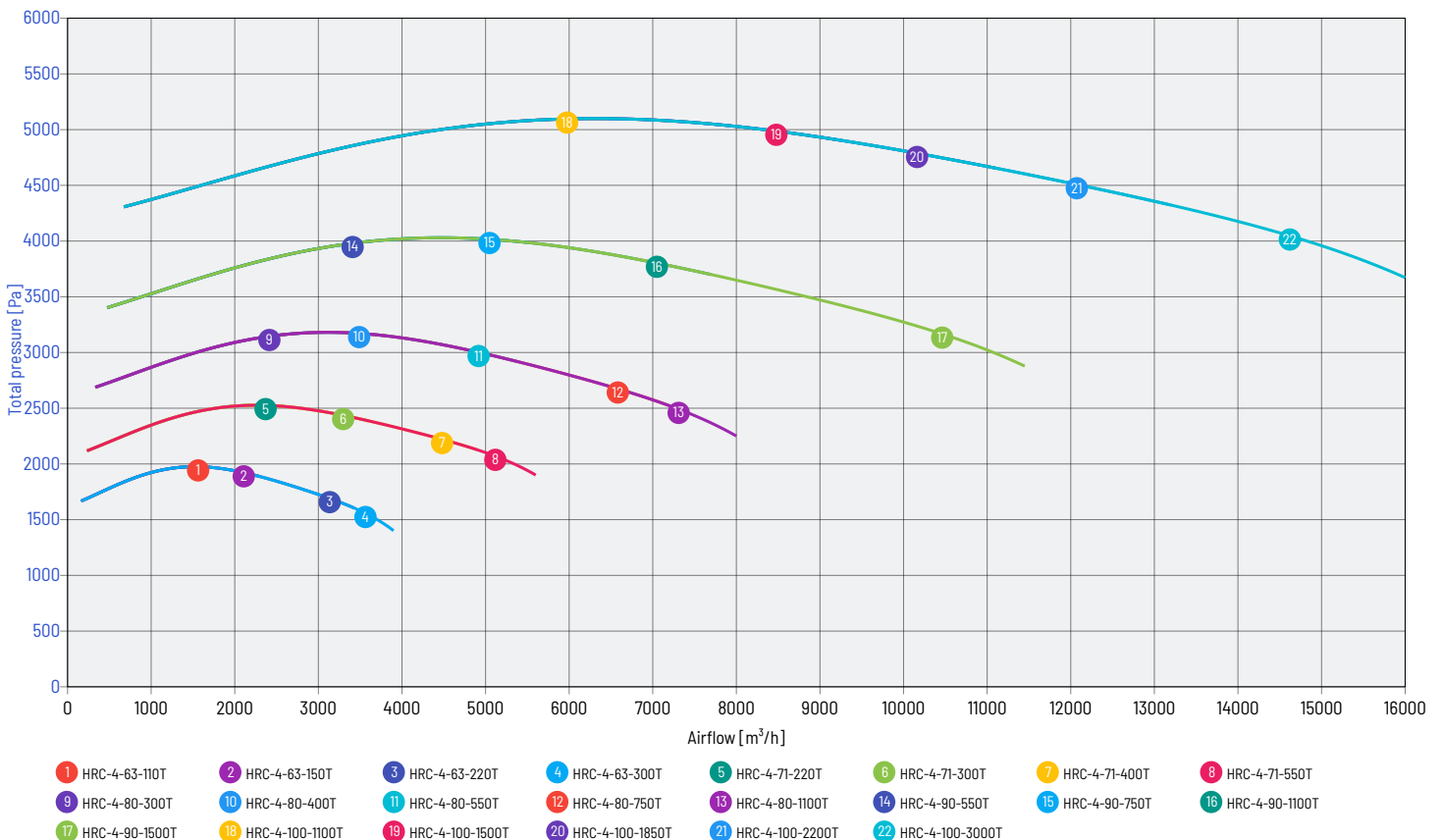



PERFORMANCE CHARACTERISTICS OF THE FANS

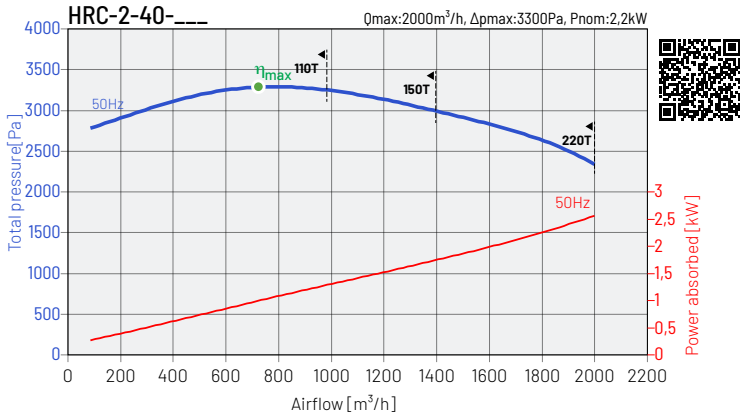

	MC	EC	SR	VSD	η %	N	kW	m³/h	Pa	rpm
110T	C	static	1	no	57,5	63,8	1,04	723	2 966	2 890
150T	C	static	1	no	60,5	66,8	1,02	732	3 038	2 925
110T	C	static	1	no	60,8	67,1	1,00	728	3 007	2 910

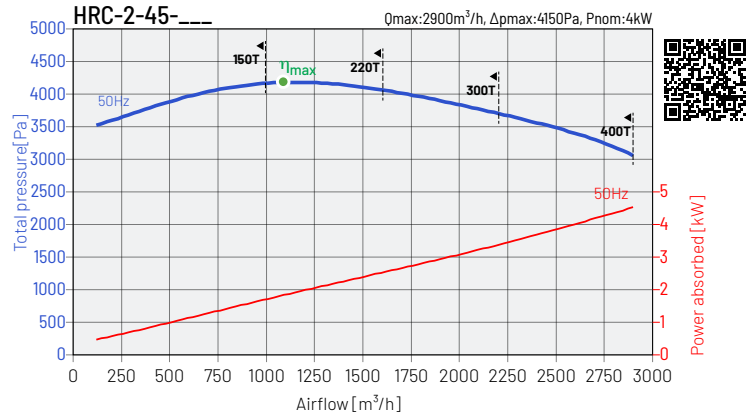

	MC	EC	SR	VSD	η %	N	kW	m³/h	Pa	rpm
150T	C	static	1	no	61,4	66,1	1,84	1048	3 881	2 925
220T	C	static	1	no	61,7	66,4	1,80	1043	3 841	2 910
300T	C	static	1	no	60,6	65,4	1,78	1032	3 762	2 880
400T	C	static	1	no	62,3	67,1	1,76	1037	3 801	2 895

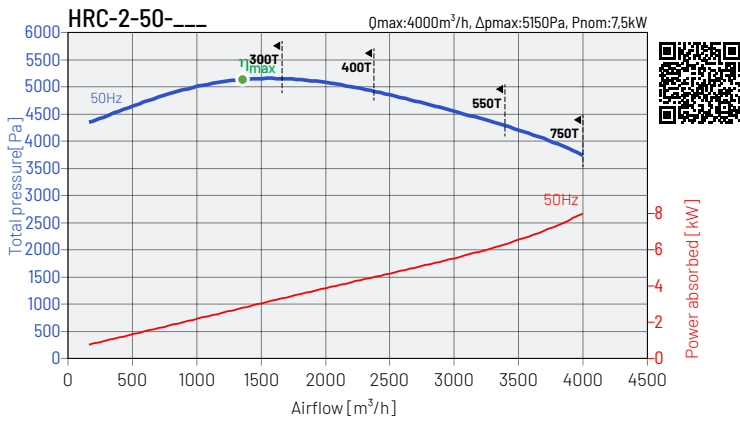

	MC	EC	SR	VSD	η %	N	kW	m³/h	Pa	rpm
300T	C	static	1	no	60,6	64,0	3,01	1415	4 647	2 915
400T	C	static	1	no	60,1	63,4	2,98	1405	4 583	2 895
550T	C	static	1	no	63,7	67,1	2,94	1427	4 727	2 940
750T	C	static	1	no	63,7	67,1	2,91	1422	4 695	2 930

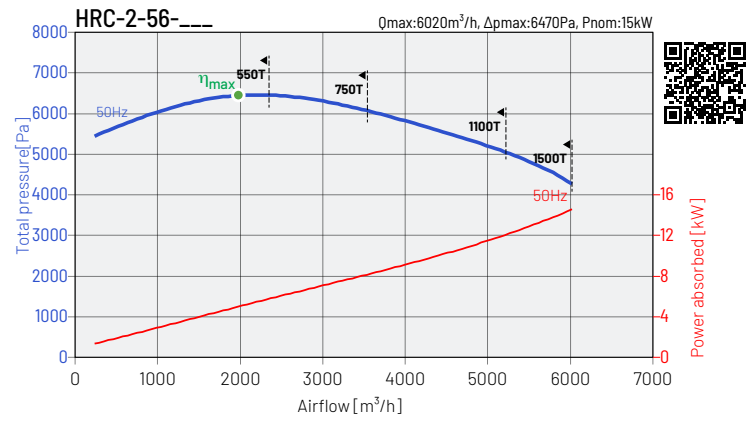

	MC	EC	SR	VSD	η %	N	kW	m³/h	Pa	rpm
550T	C	static	1	no	64,4	66,2	5,18	1998	6 010	2 940
750T	C	static	1	no	64,4	66,2	5,13	1991	5 969	2 930
1100T	C	static	1	no	64,8	66,7	5,07	1988	5 949	2 925
1500T	C	static	1	no	66,3	68,2	5,03	1998	6 010	2 940

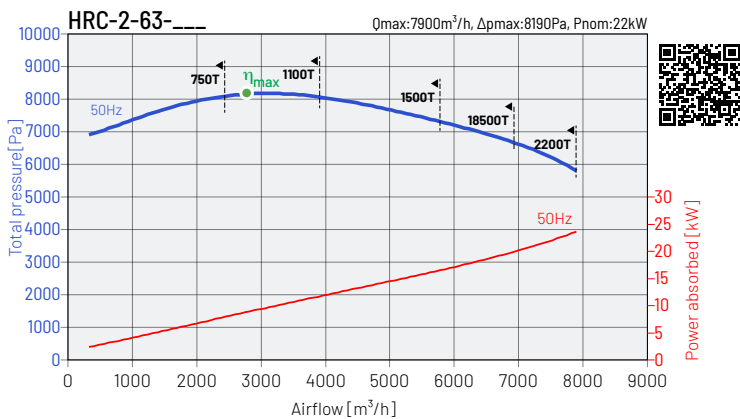

	MC	EC	SR	VSD	η %	N	kW	m³/h	Pa	rpm
750T	C	static	1	no	62,4	62,6	9,24	2 826	7 350	2 930
1100T	C	static	1	no	62,8	63,1	9,13	2 821	7 325	2 925
1500T	C	static	1	no	64,3	64,6	9,06	2 835	7 400	2 940
2200T	C	static	1	no	64,7	65,0	9,01	2 835	7 400	2 940
3000T	C	static	1	no	65,5	65,8	8,99	2 845	7 450	2 950

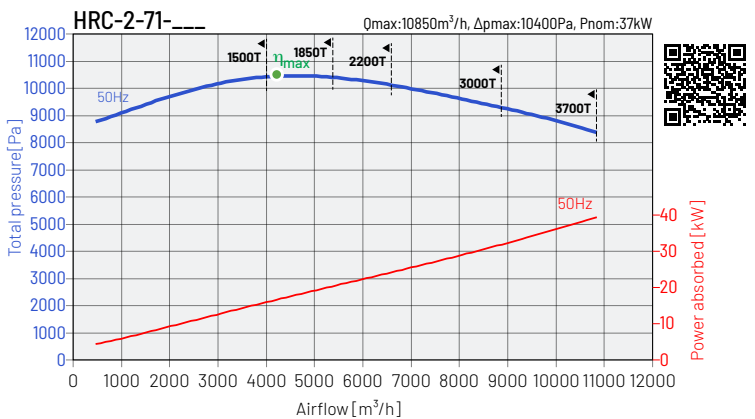

	MC	EC	SR	VSD	η %	N	kW	m³/h	Pa	rpm
1500T	C	static	1	no	64,0	63,7	16,48	4 051	9 375	2 940
1850T	C	static	1	no	64,4	64,1	16,39	4 051	9 375	2 940
2200T	C	static	1	no	65,3	65,0	16,33	4 065	9 439	2 950
3000T	C	static	1	no	66,8	66,5	16,20	4 086	9 535	2 985
3700T	C	static	1	no	66,3	66,0	16,16	4 072	9 471	2 955

The performance characteristics of the fans are determined for a medium with a temperature of 20°C. Sound pressure level dB(A), determined at a distance of 1,5 m



PERFORMANCE CHARACTERISTICS OF THE FANS

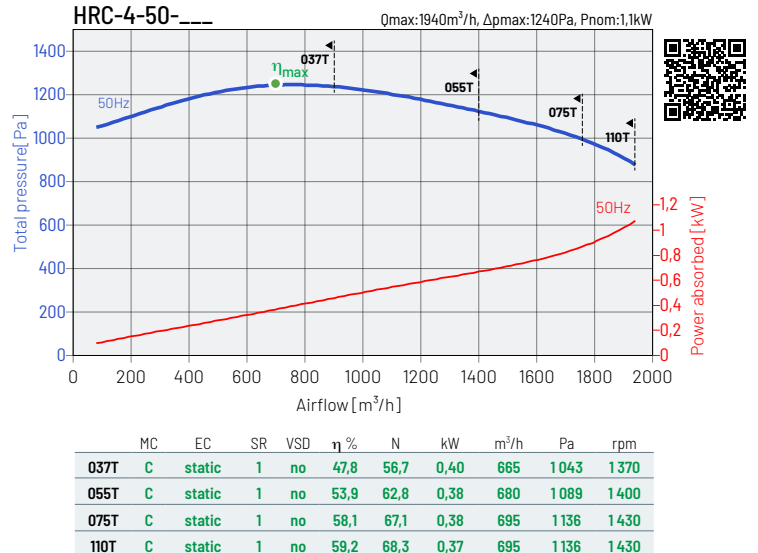
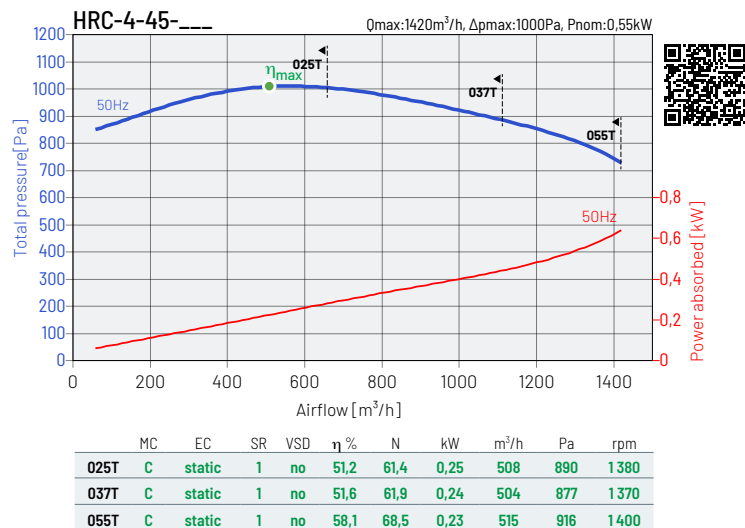
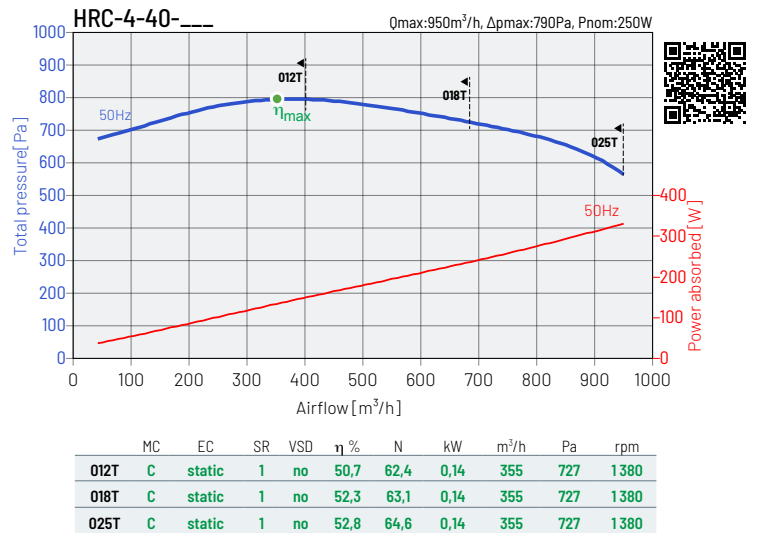
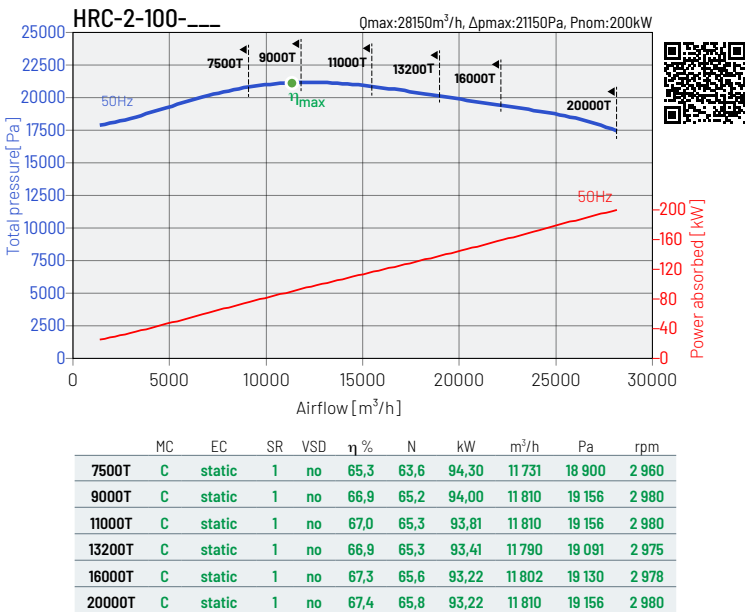
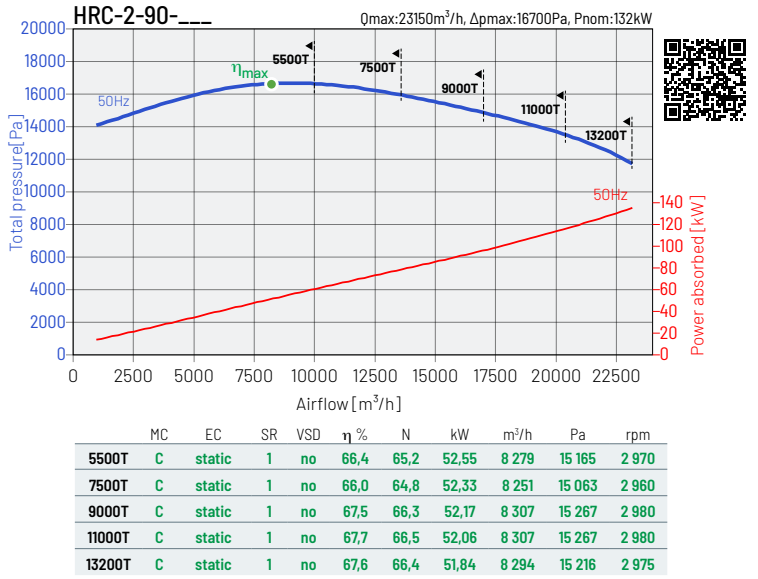
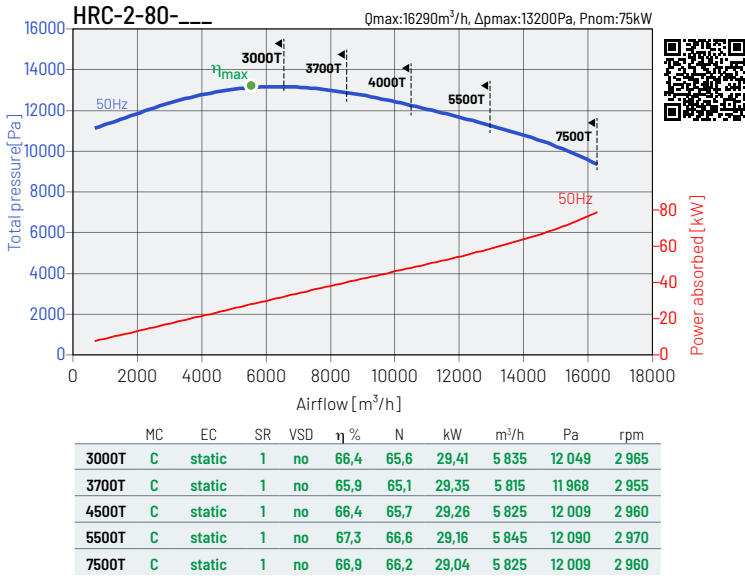

The performance characteristics of the fans are determined for a medium with a temperature of 20°C. Sound pressure level dB(A), determined at a distance of 1,5 m



PERFORMANCE CHARACTERISTICS OF THE FANS

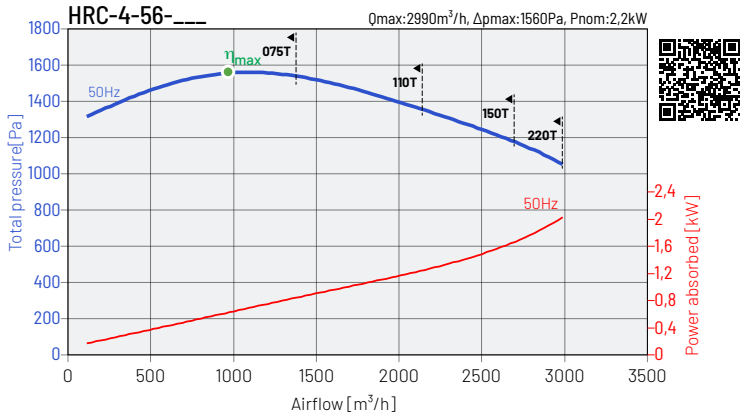

	MC	EC	SR	VSD	η %	N	kW	m ³ /h	Pa	rpm
075T	C	static	1	no	55,4	62,8	0,67	958	1384	1430
110T	C	static	1	no	56,4	63,9	0,65	958	1384	1430
150T	C	static	1	no	58,5	66,0	0,64	965	1403	1440
220T	C	static	1	no	62,6	70,1	0,63	982	1452	1465

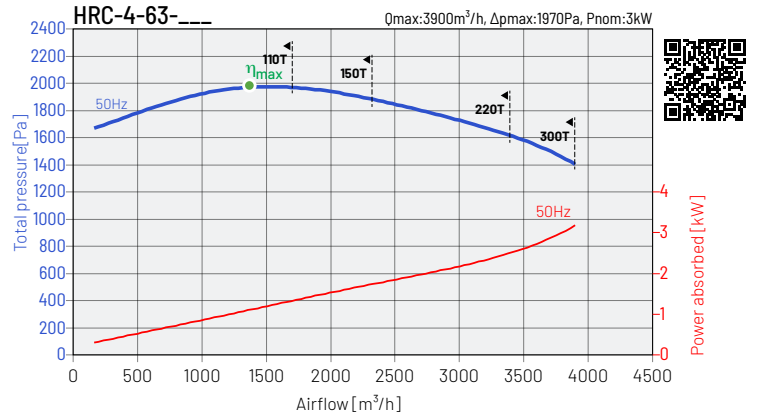

	MC	EC	SR	VSD	η %	N	kW	m ³ /h	Pa	rpm
110T	C	static	1	no	55,6	61,4	1,18	1360	1729	1430
150T	C	static	1	no	57,5	63,5	1,16	1370	1753	1440
220T	C	static	1	no	61,6	67,5	1,14	1394	1814	1465
300T	C	static	1	no	61,7	67,7	1,13	1389	1802	1460

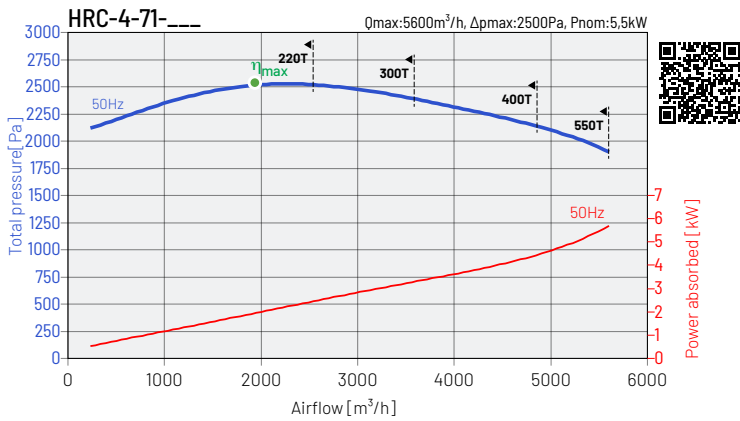

	MC	EC	SR	VSD	η %	N	kW	m ³ /h	Pa	rpm
220T	C	static	1	no	61,2	65,6	2,07	1998	2290	1465
300T	C	static	1	no	61,8	66,2	2,05	1991	2290	1460
400T	C	static	1	no	62,4	66,8	2,03	1991	2290	1460
550T	C	static	1	no	63,1	67,6	2,01	1991	2290	1460

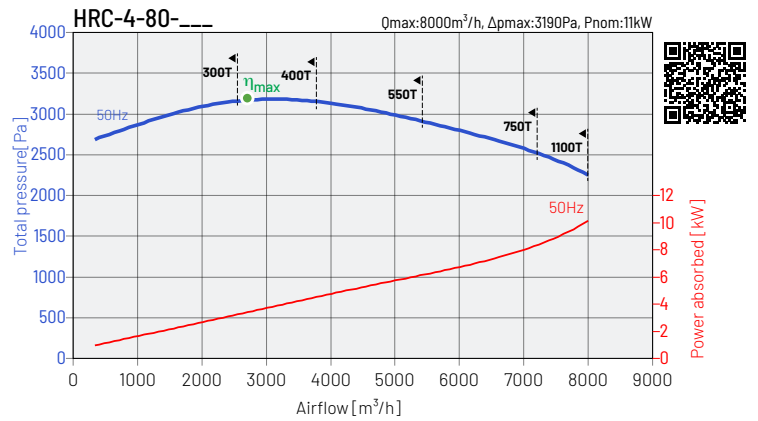

	MC	EC	SR	VSD	η %	N	kW	m ³ /h	Pa	rpm
300T	C	static	1	no	60,2	62,9	3,72	2839	2842	1460
400T	C	static	1	no	60,8	63,6	3,69	2839	2842	1460
550T	C	static	1	no	61,5	64,3	3,65	2839	2842	1460
750T	C	static	1	no	62,7	65,5	3,61	2849	2861	1465
1100T	C	static	1	no	64,7	67,5	3,57	2868	2900	1475

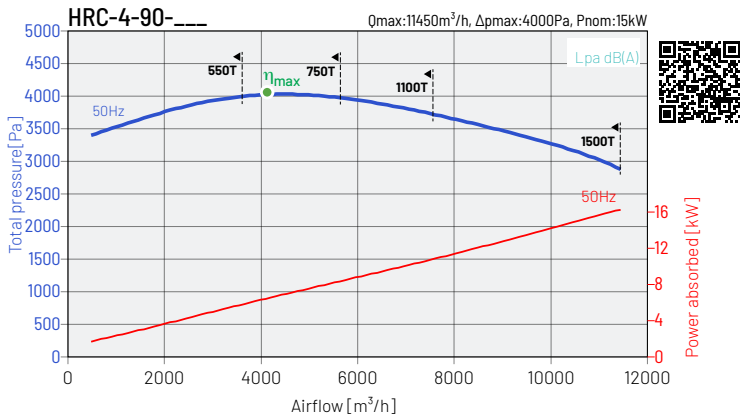

	MC	EC	SR	VSD	η %	N	kW	m ³ /h	Pa	rpm
550T	C	static	1	no	61,4	62,5	6,57	4027	3602	1460
750T	C	static	1	no	62,6	63,7	6,51	4041	3627	1465
1100T	C	static	1	no	64,6	65,8	6,44	4069	3677	1475
1500T	C	static	1	no	65,1	66,3	6,39	4069	3677	1475

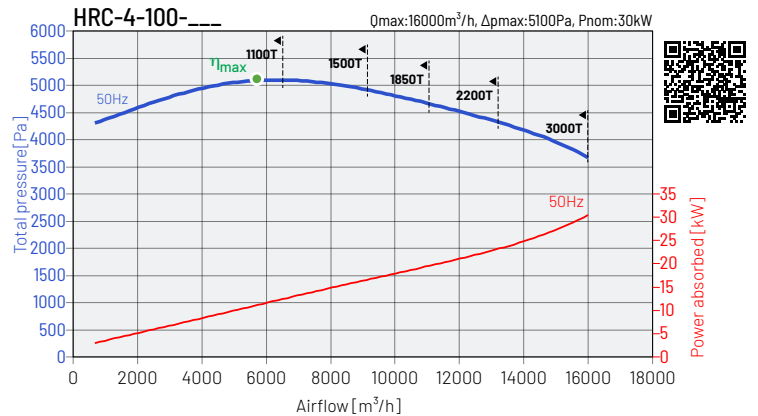

	MC	EC	SR	VSD	η %	N	kW	m ³ /h	Pa	rpm
1100T	C	static	1	no	64,0	63,6	11,60	5796	4614	1475
1500T	C	static	1	no	64,5	64,2	11,51	5796	4614	1475
1850T	C	static	1	no	64,9	64,5	11,45	5796	4614	1475
2200T	C	static	1	no	65,2	64,8	11,40	5796	4614	1475
3000T	C	static	1	no	66,0	65,7	11,31	5804	4627	1477

The performance characteristics of the fans are determined for a medium with a temperature of 20°C. Sound pressure level dB(A), determined at a distance of 1,5 m



DIMENSIONS

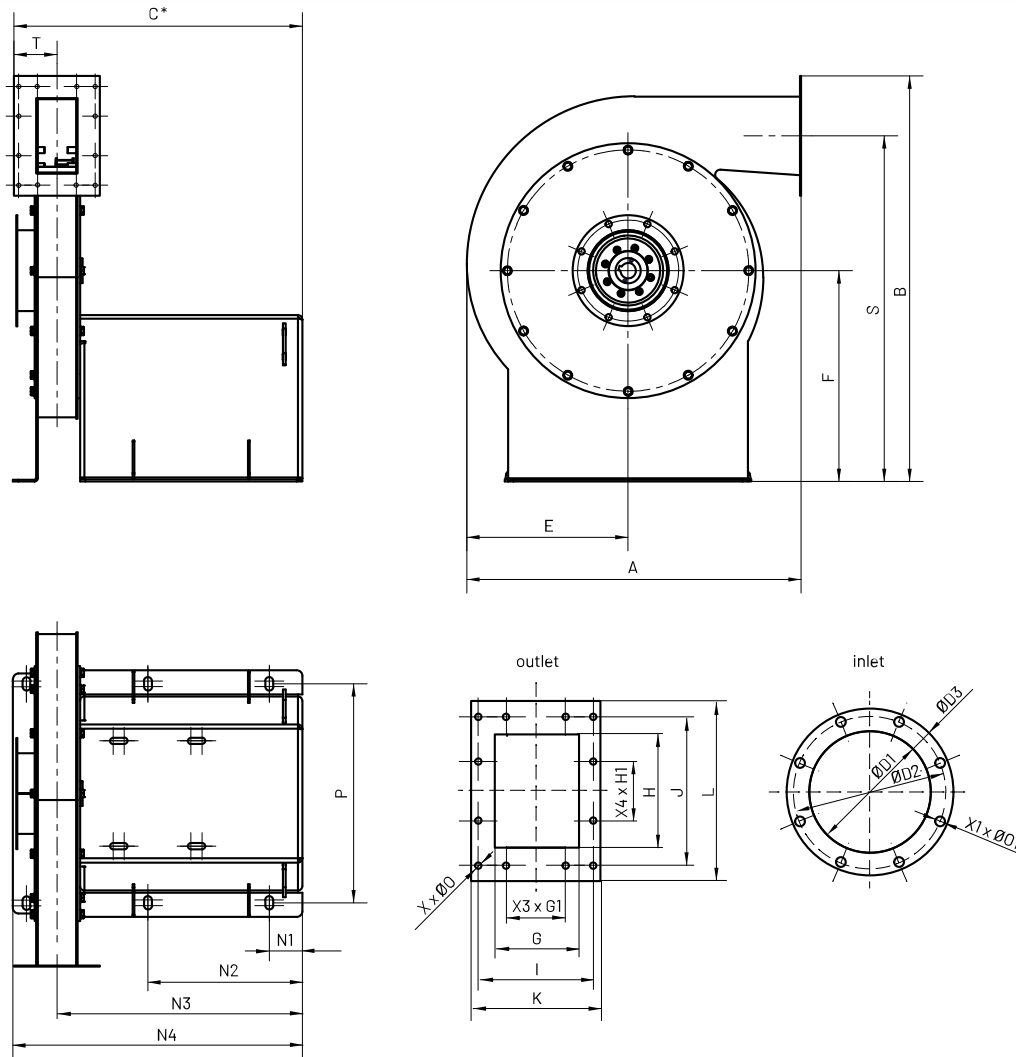

type	A	B	C*	ØD1	ØD2	ØD3	E	F	G	H	I	J
	mm	mm	mm	mm	mm	mm	mm	mm	mm	mm	mm	mm
HRC-x-40x	603	731	520	140	182	200	291	380	69	132	138	178
HRC-x-45x	678	770	528	160	200	220	326	380	77	148	138	178
HRC-x-50x	754	814	532	180	219	240	362	390	85	165	138	198
HRC-x-56x	837	840	544	200	241	260	405	380	108	185	138	218
HRC-x-63x	937	964	544	225	265	290	455	450	108	208	138	238
HRC-x-71x	1114	1076	551	250	292	310	512	500	118	235	138	262
HRC-x-80x	1209	1261	700	280	332	360	577	600	137	264	178	318
HRC-x-90x	1340	1478	838	315	366	390	648	750	155	297	198	318
HRC-x-100x	1483	1518	867	355	405	430	720	750	172	330	218	393

* dimension for the longest motor version (depending on the motor manufacturer)

type	K	L	N1	N2	N3	N4	P	S	X1 x Ø01	X3 x G1	X4 x H1	X x Ø0
	mm	mm	mm	mm	mm	mm	mm	mm	mm	mm	mm	mm
HRC-x-40x	155	216	61	280	443	522	395	623	8x11,5	1x71	1x71	12x7
HRC-x-45x	163	232	61	341	447	530	395	654	8x11,5	1x71	1x71	12x7
HRC-x-50x	164	239	61	341	451	539	395	694	8x11,5	1x71	1x100	12x7
HRC-x-56x	164	239	60	340	462	561	395	720	8x11,5	1x71	1x100	12x7
HRC-x-63x	164	262	60	340	462	561	395	833	8x11,5	1x71	1x100	12x7
HRC-x-71x	164	289	59	339	469	575	420	932	8x11,5	1x71	1x100	12x7
HRC-x-80x	223	348	79	399	589	702	600	1087	8x11,5	1x71	1x125	12x10
HRC-x-90x	221	361	106	526	681	834	740	1297	8x11,5	1x100	1x125	12x10
HRC-x-100x	258	414	86	506	689	864	740	1309	8x11,5	1x100	2x125	14x10



FIGURES

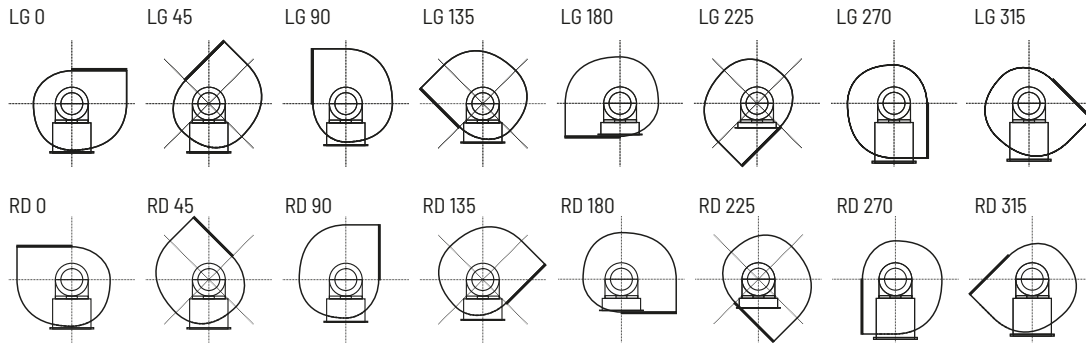

ELECTRICAL ACCESSORIES



type	inverter L	service switch	type	inverter L	service switch	type	inverter L	service switch
HRC-2-40-110T	L 1,5 kW	R-S 3-F + SP, 10A	HRC-2-80-3700T	on request	on request	HRC-4-56-110T	L 1,5 kW	R-S 3-F + SP, 10A
HRC-2-40-150T	L 1,5 kW	R-S 3-F + SP, 10A	HRC-2-80-4500T	on request	on request	HRC-4-56-150T	L 1,5 kW	R-S 3-F + SP, 10A
HRC-2-40-220T	L 2,2 kW	R-S 3-F + SP, 10A	HRC-2-80-5500T	on request	on request	HRC-4-56-220T	L 2,2 kW	R-S 3-F + SP, 10A
HRC-2-45-150T	L 1,5 kW	R-S 3-F + SP, 10A	HRC-2-80-7500T	on request	on request	HRC-4-63-110T	L 1,5 kW	R-S 3-F + SP, 10A
HRC-2-45-220T	L 2,2 kW	R-S 3-F + SP, 10A	HRC-2-90-5500T	on request	on request	HRC-4-63-150T	L 1,5 kW	R-S 3-F + SP, 10A
HRC-2-45-300T	L 4,0 kW	R-S 3-F + SP, 10A	HRC-2-90-7500T	on request	on request	HRC-4-63-220T	L 2,2 kW	R-S 3-F + SP, 10A
HRC-2-45-400T	L 4,0 kW	R-S 3-F + SP, 10A	HRC-2-90-9000T	on request	on request	HRC-4-63-300T	L 4,0 kW	R-S 3-F + SP, 10A
HRC-2-50-300T	L 4,0 kW	R-S 3-F + SP, 10A	HRC-2-90-11000T	on request	on request	HRC-4-71-220T	L 2,2 kW	R-S 3-F + SP, 10A
HRC-2-50-400T	L 4,0 kW	R-S 3-F + SP, 10A	HRC-2-90-13200T	on request	on request	HRC-4-71-300T	L 4,0 kW	R-S 3-F + SP, 10A
HRC-2-50-550T	L 5,5 kW	R-S 3-F + SP, 16A	HRC-2-100-7500T	on request	on request	HRC-4-71-400T	L 4,0 kW	R-S 3-F + SP, 10A
HRC-2-50-750T	L 7,5 kW	R-S 3-F + SP, 16A	HRC-2-100-9000T	on request	on request	HRC-4-71-550T	L 5,5 kW	R-S 3-F + SP, 16A
HRC-2-56-550T	L 5,5 kW	R-S 3-F + SP, 16A	HRC-2-100-11000T	on request	on request	HRC-4-80-300T	L 4,0 kW	R-S 3-F + SP, 10A
HRC-2-56-750T	L 7,5 kW	R-S 3-F + SP, 16A	HRC-2-100-13200T	on request	on request	HRC-4-80-400T	L 4,0 kW	R-S 3-F + SP, 10A
HRC-2-56-1100T	L 11,0 kW	R-S 3-F + SP, 25A	HRC-2-100-16000T	on request	on request	HRC-4-80-550T	L 5,5 kW	R-S 3-F + SP, 16A
HRC-2-56-1500T	L 15,0 kW	R-S 3-F + SP, 40A	HRC-2-100-20000T	on request	on request	HRC-4-80-750T	L 7,5 kW	R-S 3-F + SP, 16A
HRC-2-63-750T	L 7,5 kW	R-S 3-F + SP, 16A	HRC-4-40-012T	L 0,4 kW	R-S 3-F + SP, 10A	HRC-4-80-1100T	L 11,0 kW	R-S 3-F + SP, 25A
HRC-2-63-1100T	L 11,0 kW	R-S 3-F + SP, 25A	HRC-4-40-018T	L 0,4 kW	R-S 3-F + SP, 10A	HRC-4-90-550T	L 5,5 kW	R-S 3-F + SP, 16A
HRC-2-63-1500T	L 15,0 kW	R-S 3-F + SP, 40A	HRC-4-40-025T	L 0,4 kW	R-S 3-F + SP, 10A	HRC-4-90-750T	L 7,5 kW	R-S 3-F + SP, 16A
HRC-2-63-1850T	L 18,5 kW	R-S 3-F + SP, 40A	HRC-4-45-025T	L 0,4 kW	R-S 3-F + SP, 10A	HRC-4-90-1100T	L 11,0 kW	R-S 3-F + SP, 25A
HRC-2-63-2200T	L 22,0 kW	R-S 3-F + SP, 40A	HRC-4-45-037T	L 0,4 kW	R-S 3-F + SP, 10A	HRC-4-90-1500T	L 15,0 kW	R-S 3-F + SP, 40A
HRC-2-71-1500T	L 15,0 kW	R-S 3-F + SP, 40A	HRC-4-45-055T	L 0,75 kW	R-S 3-F + SP, 10A	HRC-4-100-1100T	L 11,0 kW	R-S 3-F + SP, 25A
HRC-2-71-1850T	L 18,5 kW	R-S 3-F + SP, 40A	HRC-4-50-037T	L 0,4 kW	R-S 3-F + SP, 10A	HRC-4-100-1500T	L 15,0 kW	R-S 3-F + SP, 40A
HRC-2-71-2200T	L 22,0 kW	R-S 3-F + SP, 40A	HRC-4-50-055T	L 0,75 kW	R-S 3-F + SP, 10A	HRC-4-100-1850T	L 18,5 kW	R-S 3-F + SP, 40A
HRC-2-71-3000T	L 30,0 kW	R-S 3-F + SP, 63A	HRC-4-50-075T	L 0,75 kW	R-S 3-F + SP, 10A	HRC-4-100-2200T	L 22,0 kW	R-S 3-F + SP, 63A
HRC-2-71-3700T	on request	on request	HRC-4-50-110T	L 1,5 kW	R-S 3-F + SP, 10A	HRC-4-100-3000T	L 30,0 kW	R-S 3-F + SP, 63A
HRC-2-80-3000T	L 30,0 kW	R-S 3-F + SP, 63A	HRC-4-56-075T	L 0,75 kW	R-S 3-F + SP, 10A			

Article numbers

40016450 Inverter 0.4kW	40016456 Inverter 7.5kW	91040908-01 R-S 3-F + SP, 10A
40016451 Inverter 0.75kW	40016457 Inverter 11.0kW	91040908 R-S 3-F + SP, 16A
40016452 Inverter 1.5kW	40016458 Inverter 15.0kW	91040910 R-S 3-F + SP, 25A
40016453 Inverter 2.2kW	40016459 Inverter 18.5kW	91040924 R-S 3-F + SP, 40A
40016454 Inverter 4.0kW	40016460 Inverter 22.0kW	91040911-03 R-S 3-F + SP, 63A
40016455 Inverter 5.5kW	Inverter 30.0kW	