





OPERATION AND ASSEMBLY MANUAL
OF CENTRIFUGAL FANS
TYPE EGT - ...

-  II 2G Ex h IIB T3 Gb
-  II 2G Ex h IIB T4 Gb
-  II 2D Ex h IIIC T125°C Db

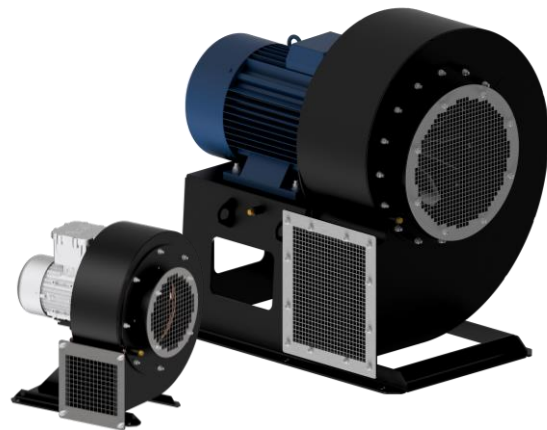

Venture Industries Sp. z o. o.
ul. Mokra 27, 05-092 Łomianki – Kiełpin, Warszawa, Polska
tel. (+48 22) 7519550, fax (+48 22) 7512259
e-mail: venture@venture.pl

INTRODUCTION

This manual covers fan listed on frontpage. It is source of information necessary for safe and proper use. Read this manual carefully before any use of the device, comply with it requirements and keep it in place with easy access for users and service. In case of any doubts about use of the fan, please contact with manufacturer.



Additional requirements about use of the unit can be found in electric motor documentation and markings - those requirements need to be met.



After receiving the device – check



- Whether the device is in compliance with order?
- Whether the data on the nameplate are the same as desired?
- Whether fan was not damaged during transport (e.g. there are no dents/cracks)?
- Whether the ATEX classification is compatible with the order?
- Whether the following documentation is attached as an annex to this manual:

1.	Fan manual – this document
2.	Motor manual
3.	Declaration of Conformity/ of Incorporation of the fan
4.	Declaration of Conformity of electric motor
5.	Construction drawing with general dimensions
6.	Construction drawing with minimal distances between rotating parts
7.	Construction drawing with signs
8.	Construction drawing with exploded views
9.	Certificate of quality control

In case of any irregularities, contact with your dealer or Venture Industries Sp. z o.o. service.

ATEX code

The fan was made in ATEX specification (applies to interior and surrounding of the fan):

	II	2G	Ex h	IIB	T3	Gb
	II	2G	Ex h	IIB	T4	Gb
	II	2D	Ex h	IIIC	T125°C	Db

Where:

	Explosion proof sign,	IIB	Explosive gas group – gas mixtures of ethylene group,
II	Group of explosion proof device (device for operate outside mining),	IIIC	Explosive dust group – conductive dust,
2	Category of device to operate in hazardous area,	T3 / T4	Maximum surface temperature for gas,
G	Device for work in an explosive gas atmosphere,	T125°C	Maximum surface temperature for dust.
D	Device for work in an explosive dust atmosphere,	Gb/Db	The Equipment Protection Levels (EPL)
Ex h	Type of protection – in this case constructional safety,		

1. GENERAL INFORMATION

1.1 Information about device

- The fan is a not completed machine within the meaning of the Machinery Directive 2006/42/WE (please refer to the manufacturer's declaration).
- Fan is designed for use by trained, qualified adult persons in industrial environment. The fan is not designed for household or similar use.
- The device is designed to transport of an Ex classification material corresponding to the ATEX classification of the fan. **It is forbidden to transport solids, liquids, substances causing abrasion, chemically aggressive compounds.** Operating temperature of the transported medium is determined on the nameplate of the fan.
- The fan must be protected from the weather (e.g. snow, rain, excessive sun radiation, lightning). The device is not designed to be installed outdoor. The fan surrounding cannot contain **explosive atmospheres other than fan ATEX specification**, substances causing abrasion, chemically aggressive substances, viscous substances, liquid, substances with high humidity.
- The permissible ambient temperature range is -20 ° C to 60 ° C (or narrower according to nameplate) and the temperature of the medium at the fan inlet is -20 ° C to 60 ° C.
- The device must not be exposed to radiation (such as microwave, UV, laser, x-ray).
- Fan is designed for environment with pressure 0,8 – 1,1 bar, contains maximum 21% oxygen (volume). Operational parameters are valid for air density $\rho = 1,2 \text{ kg / m}^3$.
- The impeller has been balanced in accordance with minimum G2.5 class ISO 1940-1, and general construction of the fan in accordance with cat. BV-3 ISO 14694.
- The device can operate at a speed not higher than indicated on the fan nameplate.
- Description of construction of the fan has been included in Appendix D.
- Additional information of the fan usage has been indicated on the device. Additional information have been included in Appendix A.

1.2 General risk and guidelines

During entire fan life cycle pay particular attention to the **risk and guidelines** presented below:

1.2.1 moveable components

- The fan is equipped with moveable components (impeller of the device, impeller of the motor). Contact with them may cause serious injury or death. The fan must not be used if covers (grids) and safety measures against contact with rotating parts have not been installed.



1.2.2 suction

- The fan has high suction power. Clothing, hair, foreign particles, and even body elements can be easily sucked in. It is forbidden to approach the fan in "loose" clothing or reaching toward inlet of working fan and motor impeller. It need to be ensured, that no foreign body can be sucked in.

1.2.3 thrown elements

- The air at the outlet of the fan has high energy. Elements sucked or placed inside the fan can be thrown with a high speed. The fan has stable, solid construction, but as a result of damage or improper use some parts (elements with high kinetic energy) may be thrown away. Do not use fan without proper inlet, outlet and moveable elements covers (grids). Make sure that before start and during operation of the fan there are no elements, that may be sucked in (pay special attention to fan inlet side) and there are no person in stream of transported medium (on inlet and outlet side).
- The device was not made as gas tight.

1.2.4 sharp edges

- During manufacturing the fan sharp edges was grinded. However the fan may have edges touching which may cause injury. We recommend the use of relevant protective gloves.



1.2.5 inertness

- The fan has a high inertness. In case of no permanent fix turning on the fan will lead to it uncontrolled movement. The unit can be turn on only after proper installation.

1.2.6 noise

- The sound pressure level is dependent on the operation point. Check the sound pressure level and if necessary use silencers and/or individual protection measures for personnel. The value of the sound pressure level generated by the fan was placed on the website www.venture.pl.

1.2.7 materials

- In case of fire or transport of improper medium – fan parts can generate fumes hazardous to health.

1.2.8 environment

- The fan can make over and under pressure. In areas where a specified air pressure and the quantity of air are required make sure that there would be no deficit/excess of air.

1.2.9 temperature (hot surfaces)

- The housing and fan elements take the temperature of transported medium. During work (e.g. as a result of compression process) the temperature of medium, housing and fan components increase. Electric motor heat up to high temperatures (especially when overloaded/overheated). The appropriate steps need to be made to prevent from fire and burns caused of high temperatures. In case of fire – to extinguish a fire use fire extinguisher approved for electrical equipment and follow recommendation of fire department.



1.2.10 unexpected start / connecting power supply

- Before undertaking any kind of work on fan (e.g. installation, maintenance and inspection, disassembly), it has to be completely and reliably disconnected (isolated) from power supply (check there is no voltage). It has to be ensured, that power supply will not be connected during work on fan and moveable parts are not moving.



- The appropriate steps need to be made in order to provide protection against electric shock and to prevent from access to electrical components by unauthorized person.



- Fan is not equipped with control system – the connecting of power supply causes immediate start-up. The device is not equipped with system, that would permanently shut it down in case of temporary power supply loss. It has to be ensured, that any dangerous or unpermitted event does not occur in case of temporary loss of power supply.
- Thermal sensors installed in motor (if fitted) after tripping caused by motor overheat turn back to initial state after cooling down. It has to be ensured, that any dangerous or unpermitted event does not occur in case of action of thermal sensors and after motor cooling down.
- In case of impeller jamming – its unblocking may cause sudden movement. Appropriate steps need to be made in order to avoid impeller jamming. In case of impeller jamming, fan need to be completely disconnected from power supply and repaired.
- After disconnecting from power supply fan still works for certain time (moveable parts are moving) as a result of energy accumulation.

1.2.11 use

- Improper installation and/or use may lead to damage of the device and occurrence of dangerous situation. The unit can be installed, maintained, dismantled and used only by qualified and authorized personnel, in accordance to safety rules and current regulations in the country of use (including proper electrical authorization). Personnel need to be familiar with reactions caused by the fan.
- Using of fan in dismantled/uncompleted state is forbidden, e.g. without junction box cover.
- During the works (e.g. maintenance, installation) the fans surrounding need to be protected from bystanders approach.
- Any modifications of the unit are forbidden. Complicated maintenance work (such as dismantling the motor or impeller) need to be made by Venture Industries Sp. z o.o. service or with its permission - according to additional guidance. Improper assembly may lead to reduce the fan parameters, damage the unit and lead to the dangerous situation.

1.2.12 accumulation of dust

- Prevent the accumulation of dust deposit on and inside the fan. Dirt accumulated on: grids – reduce the fan parameters; impeller – may lose its balance; housing and motor – can reduce the cooling; hot surfaces (see 1.2.9) – may ignite.

1.2.13 occurrence of an explosive zone

- The guidelines mentioned in points 1.2.1 - 1.2.12 should be followed. Failure to observe them in the event of an explosive atmosphere can lead to ignition.
- The device can be installed, maintained, disassembled and operated only by qualified personnel - according to the guidelines set out in the Directive 99/92 / EC ATEX153 so-called. "ATEX USERS".
- Clearance between rotating and stationary elements must be in accordance with the technical documentation. Do not use the fan if the proper distances between static and movable elements are not maintained.
- Incorrect installation of the fan may pose a threat of ignition source. Observe the instructions in section 3.2 assembly information.
- The transport of an unsuitable medium (inadequate zone, type of gas or dust, ignition temperature, etc.) can ignite the explosive mixture. The fan may not be used for transport and work in the vicinity of mixtures other than its equivalent.
- The device is not gas tight. An explosive atmosphere inside and outside the device should be considered.
- During installation, maintenance and disassembly, the explosion hazard zone must be safe, i.e. without an explosive mixture. Before switching off the device, make sure that there is no explosive atmosphere.
- The occurrence of an explosive atmosphere in the vicinity of exposed live parts can cause ignition. Open the connection box of the device only after disconnecting the power supply.
- Different potential between the elements of the device and elements of the device and foreign elements (eg tools) can lead to the creation of an electrostatic spark. Do not use the device without an effective earth connection.
- The presence of foreign elements inside the fan can lead directly to the explosion (eg impact of the foreign element on the impeller) or indirectly (eg damage to the impeller). Do not use the fan when foreign elements (including dust) are in the middle. Effective protection against pulling foreign elements into the fan must be used.
- If there is a lightning strike in the potentially explosive atmosphere, this will create an ignition source. There is also the possibility of creating a source of ignition due to high temperatures of elements conducting the lightning discharge current, that is why the devices in the place of installation must be protected by appropriate lightning protection installations.
- Protection shall be provided at the place of installation of the device against the generation or propagation of radio frequency (RF) electromagnetic waves from 10^4 Hz to 3×10^{11} Hz, electromagnetic waves from 3×10^{11} Hz to 3×10^{15} Hz, ionizing radiation, ultrasonic waves, adiabatic compression and shockwaves that are potential sources of ignition.
- The exothermic reaction may act as a source of ignition when the rate of heat release is greater than the rate of release it outside, therefore, if possible, substances that have a tendency to self-ignition should be avoided. The user must carefully check that the gases or dust entering the fan do not consist of mixtures that can cause exothermic reactions and a higher temperature than that for which the device was designed.
- An appropriate safety distance should be maintained for transmitting devices.
- It is forbidden to transport medium containing corrosion effects, volatile particles or rust flakes. Pay special attention to the condition of the material and rust contamination of the impeller surface and the inlet nozzle. Corrosion on these elements in case of potential contact may ignite despite the use of safe material pairs.
- Contact of the fan impeller with aluminum or steel elements may cause an aluminothermal reaction. Do not let steel and aluminum elements come into contact with the impeller.



2. TRANSPORT AND STORAGE

2.1 Transport and storage guidelines

- The fan need to be transported and stored in original packaging, without excessive shocks. The device must be protected from weather conditions, transported and stored in dry, well ventilated, and free from substances harmful to the device areas. The fan cannot be transported and stored in areas with fertilizers, chlorinated lime, acids and other aggressive chemicals. Fan need to be protected against foreign body entrance.
- Protect the fan against damage (including crush). After lifting unit it need to be put slowly.
- The unit need to be lifted by housing elements. Do not lift the unit by motor elements (e.g. eye bolt). During lifting the device must remain stable.

Fig. 1.

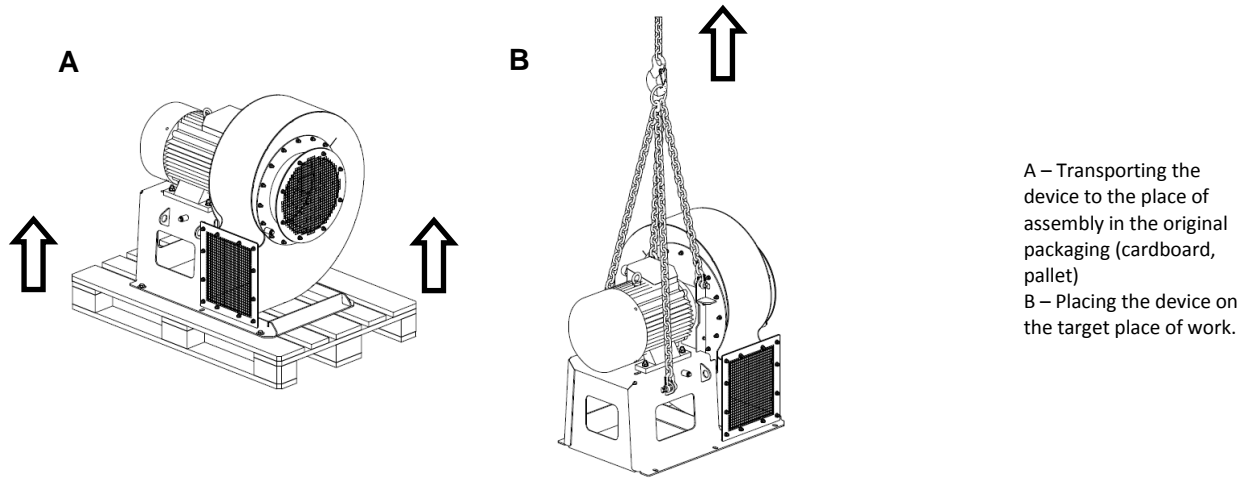

- Fans weighing less than 25 kg can be transported by hand, bearing in mind the use of appropriate protective footwear.
- Do not approach lifted device. In case of breaking, falling device may cause serious injury or death.
- It is recommended that storage time does not exceed one year. After long storage, before installation check the fan. (section 5).



3. ASSEMBLY AND INSTALLATION

3.1. General information

- During installation follow the guidelines contained in section 1.2
- The fan is a machine not ready for use (within the meaning of the Machinery Directive 2006/42/WE) - before use of the device ensure conformity with requirements of Machinery Directive 2006/42/WE.
- Before installation remove temporary items that protect fan during transport and storage (e.g. box, foil, inlet and outlet caps – do not remove any guards) – Starting the fan with those items could lead to damage of the fan. Make sure that the fan is not damaged.
- Ensure that there are no foreign bodies (e.g. mounting elements, tools) inside fan and near of the unit, the fan is properly secured after installation (the cover of connection box is closed and secured, the connecting elements are properly tightened). Technical acceptance need to be carried out in accordance with Appendix B.
- The 2D category fan must be equipped with vibration monitoring before commissioning, in accordance with PN-EN ISO 80079-37.
- If the device has inspection hatch or drain plug, it must be tightly closed before start-up.

During mechanical connection special attention need to be paid to prevent from falling solid objects and / or dirt into fan, which would lead to it damage and increase the risk of explosion.



3.2 Assembly information

- Fan need to be mounted in position presented on Fig 2., with horizontal motor shaft position, with base (A) on bottom. All holes placed in the mounting base have to be used. Ventilation installation need to be connected to fan outlet flange (B) and/or inlet shield (C) (with use of dedicated inlet flange) - all mounting holes need to be used. Fasteners secured against loosening need to be applied. Other fan installation positions possible after obtaining the manufacturer's approval.
- Installation of the fan should be carried out taking into account the guidelines set out in chapter 1.2.

Fig. 2

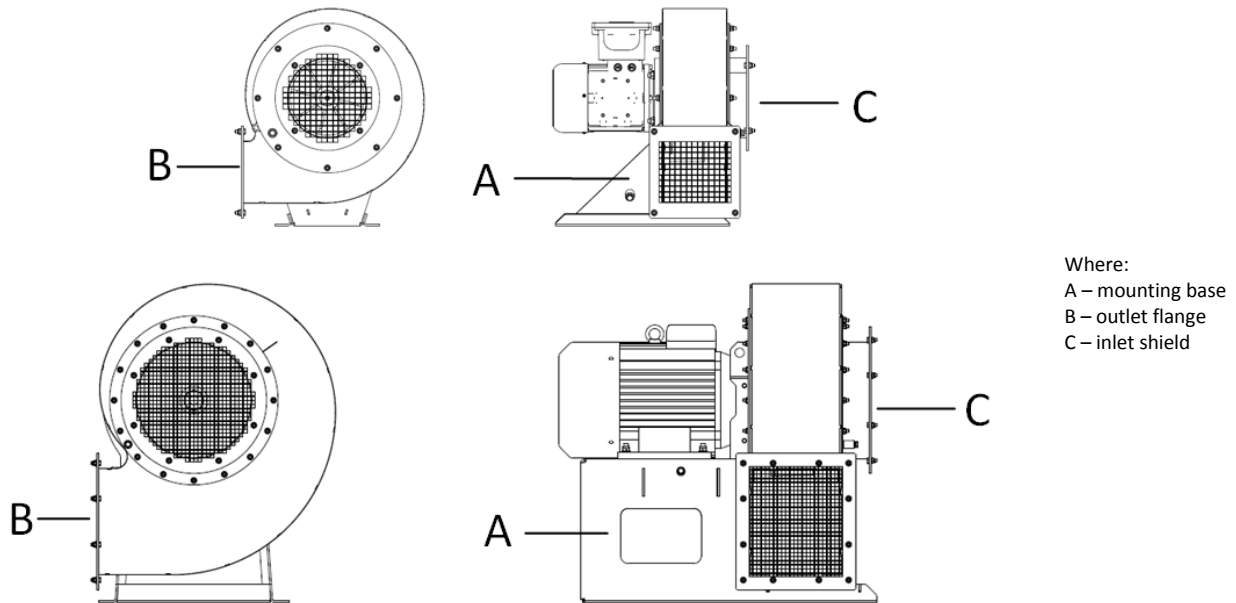

- Supporting construction has to be solid enough in order to carry the weight of the fan and generated vibration (including fan damage). The fan cannot be exposed to vibration. Furthermore, the support structure must provide proper grounding.
- Inlet and outlet covers need to be applied. Covers need to protect from touching the impeller according to PN-EN ISO 13857.
- Fan need to be secured from sucking foreign elements (see paragraph 1.2.3). Inlet and outlet covers must comply with requirements of IP20 acc. PN-EN 60529. If there is still risk of sucking foreign objects - additional protection need to be used.
- Keep safe distance between motor cooling impeller and obstacles (in accordance with motor documentation, but not less than on Fig. 3).

Fig. 3.

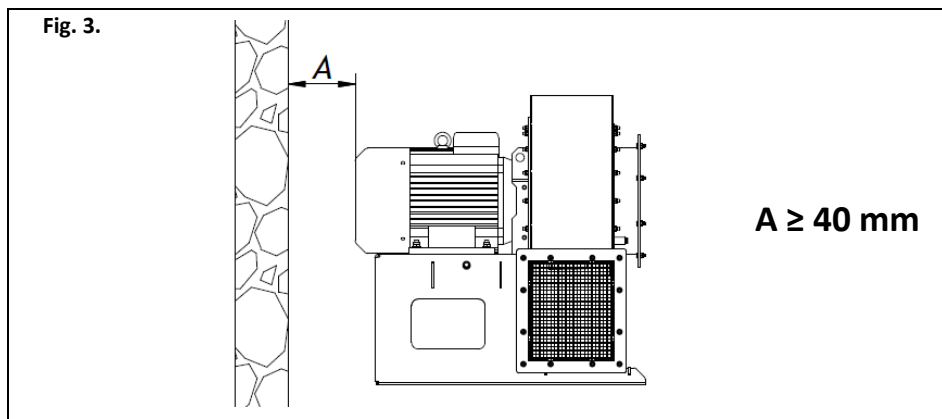

- It is recommended to apply measures minimizing transmission of vibration from/to the fan. For fans mounted in flexible form - connecting on inlet and outlet side need to be also made in flexible form.
- Keep safe distance between installed device and inflammable elements (special attention to hot surfaces of device need to be paid).
- Measures protecting user from burn by hot elements need to be applied.

3.3 Guidelines for electrical connection

- The electrical installation should be connected by qualified and authorized personnel.
- The fan and power supply network must be protected in accordance with local law requirements. Please observe the guidelines of the PN-EN 60079-14 standard, considering requirements of occurring explosive hazard zone.
- Detailed guidelines related to electrical connection are located in motor operation manual.
- Protection against short-circuits and overloads need to be applied. It is necessary to use switch that completely disconnect fan from voltage (all power phases).
- **Use appropriate protection against electric shock. Fan need to be connected to grounding system with designed for such purpose ground terminal placed in terminal box.**
- Some of fan models are equipped with PTC sensors (placed in electric motor's winding), the ends of which have been placed inside terminal box. The resistance of PTC sensor increases rapidly when the permissible temperature of the motor is exceeded. The ends of the detached sensors should be connected to the system (e.g. a resistive relay) that disconnects the fan's power supply in the event of exceeding the allowable motor temperature. Guidelines for connecting PTC thermistors (diagram) are presented in the engine manual.
- Voltage and frequency of supply network cannot exceed those indicated on the fan nameplate.

Attention: Only properly adapted motors can be powered from a frequency converter (inverter). Information on this subject can be found in the engine operation manual or from the device manufacturer.



- Use electrical wires with proper insulation and cross-section. The cables must be resistant to the temperature that may occur (see 1.2.9). Supply wires need to be placed in way excluding contact with moving elements and in a way that liquid (e.g. from condensation) does not run over them in the connection box. Cable glands need to be properly tightened.
- The fan casing should be earthed by connecting to equipotential bonding network. Cross-section of wire of earthing connection should not be less than, thickness of supply wires.

3.4 Monitoring device for control of ignition source connection guidelines

- The motors could be equipped with PTC sensors, which should be connected to a relay designed for thermal protection of this type. In the event of protection being triggered, the system must be designed in such a way as to prevent the fan from starting up automatically when the temperature drop. Information of the type of PTC sensor is given on the motor nameplate or in its documentation.
- 2D category fans must be equipped with vibration monitoring system type b1 (in accordance with PN-EN 80079-37). The motor has a place for mounting the vibration sensor, which is part of the standard equipment of fan with category 2D. The method of sensor assembly is shown in Fig.5. It depends on the size of the fan and the motor used. The vibration sensor can also be mounted in place of one of the ground terminals placed in the fan base.

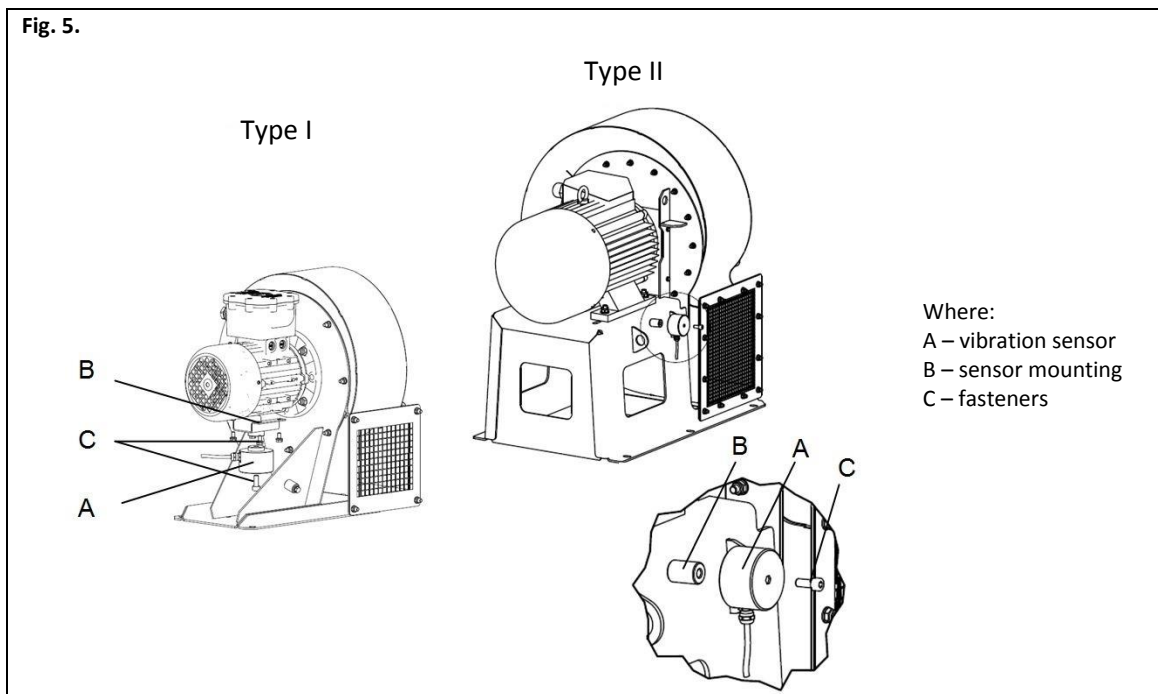

- It is recommended to use vibration monitoring also in other fan categories.
- The vibration limits for the fan monitoring system actions “Alarm” and “Shutdown” according to ISO 14694 are shown in table below. Devices used to inform about increase of vibration, should visibly and unequivocally inform about hazard of ignition.

	Rigidly mounted [mm/s]		Flexibly mounted [mm/s]	
	peak	r.m.s	peak	r.m.s.
Start-up	6,4	4,5	8,8	6,3
Alarm	10,2	7,1	16,5	11,8
Shutdown	12,7	9,0	17,8	12,5

for category BV-3 according to ISO 14694

- All elements of ignition sources monitoring systems (e.g. sensors, relays) that are located in the explosion hazard zone must have adequate explosion-proof protection.

3.5 Impeller rotation direction

Make sure that after installation and during using the fan the impeller would rotate in correct direction. After mounting fan to proper construction, with special care taken and in accordance with sector 1 and 4, launch the fan in impulse way (less than 1 second) and check, if the impeller rotates in correct direction, generating airflow in proper direction (according to direction arrows – see fig. 5., rotation direction need to be checked by checking the motor cooling impeller rotation direction). The work with impeller rotating in the wrong direction reduces fan parameters and may damage it. In case of improper impeller rotation, turn of power supply, wait until impeller stops and change proper power supplying wires in terminal box.

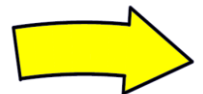

4. USE

4.1 Use guidelines

- Make sure that turning on of the fan does not make any hazard for personnel and property. Follow the guidelines featured in section 1.2.
- The fan is designed for continuous operations (S1) – too high frequency of starting a fan may lead to motor overheat and damage.
- **Fan cannot work with voltage, frequency, current higher than shown on the fan nameplate** (even if motor nameplate/manual allows it). Applying of higher frequency may cause motor damage or mechanical damage of the fan.
- **Use of fan with lowered voltage is not allowed** - it may cause e.g. lack of fan start-up and motor overheating and damage.
- It should be ensured that fan speed control will not lead to a dangerous situation, damage to the device, increased vibrations.
- It must be ensured that the device will be able to start working at the set minimum engine cold speed.
- The device cannot work with current consumption exceeding the value indicated on the nameplate (regular inspection - see chapter 5).
- In case of activation of any electrical protection, detection of damage, unit must by immediately turn out off use.
- The device is adapted to work in certain range of characteristic. Too high volume flow rate of medium, start/work of device with completely opened inlet and/or outlet may lead to motor overheat caused by current consumption exceeding value on the nameplate (current consumed by fan grows as resistance of installation decreases). Too small volume of transported medium can lead to fan operation in the area of excessive vibration (compressor stall).
- Units work parameters (temperature of medium, ambient temperature, min and max flow rate....) refer to rated speed.

Fan need to be mounted only with horizontal motor shaft position. Other fan installation positions possible after obtaining the manufacturer's approval. The assembly details are described in section 3.2 of the assembly instructions.



5. MAINTENANCE, REVIEW

5.1 Maintenance guidelines

- During maintenance and review follow the guidelines contained in point 1.2.
- Fan need to be subject of regular review and maintenance (point 5.2).
- **Maintenance and review of motor need to be overtaken in accordance with motor documentation and markings.** Replacement of motor bearings need to be taken before 20 000h of fan operation by Venture Industries Sp. z o.o. service or outside the service – after obtaining the manufacturer’s consent, according to additional guidelines.
- To clean fan construction use slightly damp delicate material. It is prohibited to use detergents, liquids under pressure and tools that may scratch the unit surface.
- The fan need to be turned on at least once a month (30 minutes recommended).
- Ensure that there are no foreign bodies (e.g. assembly components, tools) near and inside the fan, the impeller is not blocked, the unit is clean, dry and secured after maintenance and review. After cleaning finishes, turn on the fan at max speed for 30 minutes.
- During review special attention to the following need to be paid:



dust and dirt	Prevent the accumulation of dust/dirt on and inside the fan. Dirt accumulated on: grids – may reduce the fan parameters; housing and motor – can reduce the cooling; hot surfaces –may ignite. Dust deposited between rotating and static elements may cause tighten the clearance and create high temperatures due to friction. Special attention must be paid to motor cooling impeller and its cover. Reduction of cooling ability may lead to overheat of motor without working of safety devices.
corrosion	Corrosion of the fan may lead to mechanical damage of it. It is forbidden to use the fan if corrosion appears
structure deformation	Clearance between stationary and rotating parts of the fan is very important due to ignition risk. It is forbidden to use the fan if minimal clearance (information in technical documentation, attached to this manual) are not keep. Pay attention to the clearance between the impeller inlet nozzle and inlet shield.
overload	Exceeding of nominal current may be caused by improper choice of fan, mechanical damage (e.g. impeller, bearing), improper electrical connection. Current value must be controlled, and if its growth is noticed, the reason need to be determined and device need to be repaired. Current value cannot exceed nominal value.

vibration

Excessive vibration may cause mechanical damage of the fan or its mounting construction. The vibration increase can indicate bearings damage or loss of impeller balance. Vibration value needs to be controlled, and if its growth is noticed, the reason needs to be determined and the device must be repaired. Maximum vibration value on bearings (perpendicular to motor shaft) after fan installation cannot exceed the value presented in the table below:

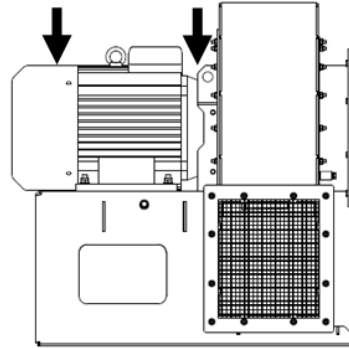

rigidly mounted*		flexible mounted*	
peak	r.m.s	peak	r.m.s.
6.4 mm/s	4.5 mm/s	8.8 mm/s	6.3 mm/s

*according to ISO 14694

Rigidly mounted – the type of mounting in which the fan is so rigidly connected to the base and ground that further increase of this stiffness does not have a significant effect on the natural frequency of the fan.

Flexible mounted – the type of mounting in which the fan is placed on vibration isolators, reducing forces from vibration transmitted from the fan to the ground.

peak – the peak value of vibrations on the motor body

r.m.s – root mean square value of vibration on the motor body

The fan designed for operation in a dust atmosphere (2D category), cannot be started without vibration monitoring. The sensor needs to be installed on the motor body, as close as possible to bearings, measuring vibrations in the perpendicular direction to the motor shaft.

5.2 Review and maintenance

- The set between routine checks and maintenance need to be determined by user, based on the observation of unit and specific conditions of use, in order to include specific work conditions. The set cannot be longer than introduced below.
- In the case of irregularities the device must be turn off and subjected to review, maintenance and possible repairs / cleaning (when dirt occurs). Examples of reasons for device to work in emergency mode are given in Appendix C.
- Staff operating the device must be familiar with it normal working conditions. If the fan work differ from it normal working conditions it need to be turn off from work and inspected.
- Detailed information about components and it tightening torque is available on request.

Recommended daily review, not less frequently than once a week.:

- Device is undamaged, stable and works properly,
- There are not any leaks, smoke from motor,
- Device does not emit any untypical noise, and does not heat up excessively,
- Device is clean (general control), corrosion does not occur (general control),
- Wires are not damaged,
- There are no untypical leaks from fan,
- Covers are in proper state and clean.

Monthly review

- Fan current value is not higher than beginning value,
- The values of generated vibration did not increase (according to beginning value),
- Device and covers are clean, there is no leaks,
- Device is clean, filter is not clogged (if used).

Review once per 3 months, not less than 6 month and 3000 hours of work

- Corrosion does not occur,
- Fasteners state is proper (they are properly tightened),
- Security devices are working and set properly, protection against electrical shock is effective,
- Motor insulation resistance value is correct,
- Structure is complete, components are not damaged (e.g. by abrasion),
- The clearance between impeller and stationary elements is consistent with documentation.

Constant review

- Temperature of motor has not been exceeded (PTC thermistor),
- Vibration monitoring (2D category – obligatory, 2G category – recommended).

Fan review made by Venture Industries Sp. z o.o. service is recommended.



6. REPAIR, WARRANTY





Use only original spare parts and original accessories. Fan repairs need to be made by Venture Industries Sp. z o.o. service or outside, after manufacturer permission. Warrantee conditions are described in guarantee card.

7. DISMANTLING AND RECYCLING

Disconnect unit from its power supply, and dismantle according to the guidelines from section 1 of this instruction. Therefore, please deposit all left-over material and packaging in their corresponding recycling containers and hand in the replaced machines to the nearest handler of this type of waste product.

Appendix - A (Product marking)

Fan nameplate:

	Venture Industries Sp. z o.o. Mokra 27, 05-092 Łomianki-Kielpin Warszawa, Poland www.venture.pl		Fan Type / Size:			
			[1]			
MOTOR TYPE	[2]	[9]	Hz	[10]		
PROD. YEAR / SERIAL	[3]	[11]	IP	INS.CL.	[19]	
TOTAL WEIGHT [4] kg	JOB REF. NO. [5]	[12]	V	[13]	A	
MAX. PERMISSIBLE RUNNING SPEED rpm [6]	TEMPERATURE RANGE [21]		[14]	rpm	[15] kW	
CATEGORY [7] INSIDE	CATEGORY [8] OUTSIDE	[16]	Pa	[17]	m ³ /h	
 		[20]		 [18]		
Refer to Installation and Operation Manual before starting operation. Przed użyciem wentylatora należy zapoznać się z instrukcją obsługi i montażu.						

where:

- | | |
|--|---|
| [1] Fan type / Size, | [11] Motor IP protection |
| [2] Motor Type | [12] Nominal voltage of a system, V |
| [3] Production year / Serial | [13] Rated current, A |
| [4] Total weight, kg | [14] Rated running speed, rpm |
| [5] Job reference number, | [15] Rated power of motor, kW |
| [6] Maximum permissible running speed, rpm | [16] Maximum total pressure, Pa |
| [7] Category of hazardous area for group II inside fan casing (2G or 2D), | [17] Maximum duty, m ³ /h |
| [8] Category of hazardous area for group II outside fan casing (2G or 2D), | [18] Hazardous parameters of fan – possible markings (Ex h IIB T3 or Ex h IIIC T125°C), |
| [9] Power rated frequency, Hz | [19] Motor insulation class, |
| [10] Article number, | [20] ATEX certificate number, |
| | [21] Permissible range of ambient temperature. |

Additional information placed on device:

According to attached documentation.

Appendix - B (The device receipt form)

Before launch	Check confirmation
Type and model of fan are in accordance with the order.	
The fan is undamaged.	
There is no foreign body inside fan, and the fan is clean.	
The fan is reliably and solidly fixed in workplace.	
The fan is properly leveled	
Wires are properly tightened.	
Ambient temperature and transported medium temperature are compatible with fan nameplate	
Proper electrical protection is applied	
Grounding of fan is applied.	
Network power supply is compatible with fan power supply.	
Power supply disconnecting switch is applied.	
Personnel using the fan read and understood the operation and montage manual.	
Proper inlet and outlet covers (grids) have been applied	
Inspection hatch and drain plug are tightly closed.	
After fan launch (continuous work period minimum 30 minutes)	
Readings and set of vibration measurement device has been written (they are available in future)	
Readings and set of current measurement device has been written (they are available in future)	
Value of current for each of phase does not exceed nominal one	
The vibration value is not higher than permitted.	

Appendix - C (Examples of device faulty working)

SYMPTOMS	POSSIBLE REASON
Excessive vibration or noise	<ul style="list-style-type: none"> • Used or damaged impeller • Fan levelled in wrong way • Dirt accumulated on impeller caused loss of balance; • Impeller loss of balance • Parts rubbing; • Damage or wear of bearings; • Damage of measurement system, that is responsible for signalization of excessive vibration. • Deformed motor shaft; • Loose of impeller fix screw, impeller is loose on motor shaft; • Loss of balance of motor impeller or damage of motor (wear/damage of bearing)
Motor overload, overheat (activation of thermal protection)	<ul style="list-style-type: none"> • Rubbing between fan impeller and housing; • Damage or wear of bearings; • Damage of motor windings (overheat, insulation degradation, insulation breakdown etc.); • Damage of switch or security system; lack of one phase of power supply; • Failure of one of supply phases; • Exceeding of maximum motor speed; • Too low flow; • Too often switching the motor (thermal protection – if used, or overheat); • Wrong setup of thermal protection;
Failed fan start-up	<ul style="list-style-type: none"> • Rubbing between fan impeller and housing or foreign body (e.g. tool left after installation); • Failure of one of supply phases; • Failure of supply system; • Motor connected in wrong way or damaged; • Too low supply voltage;
Too low flow	<ul style="list-style-type: none"> • Damage of device • Too low power supply frequency • Obstacles in ventilation installation • Damaged bearings

Appendix - D (Schematic diagram of the fan)

General description (simplified)

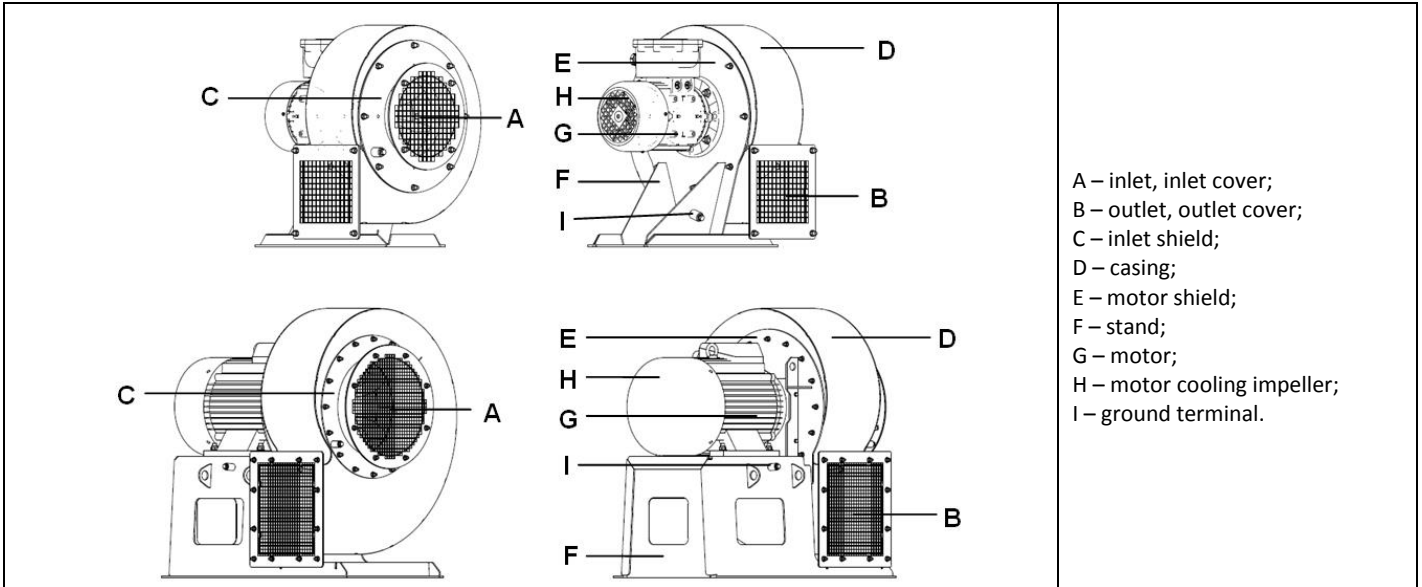

Device components description (simplified)

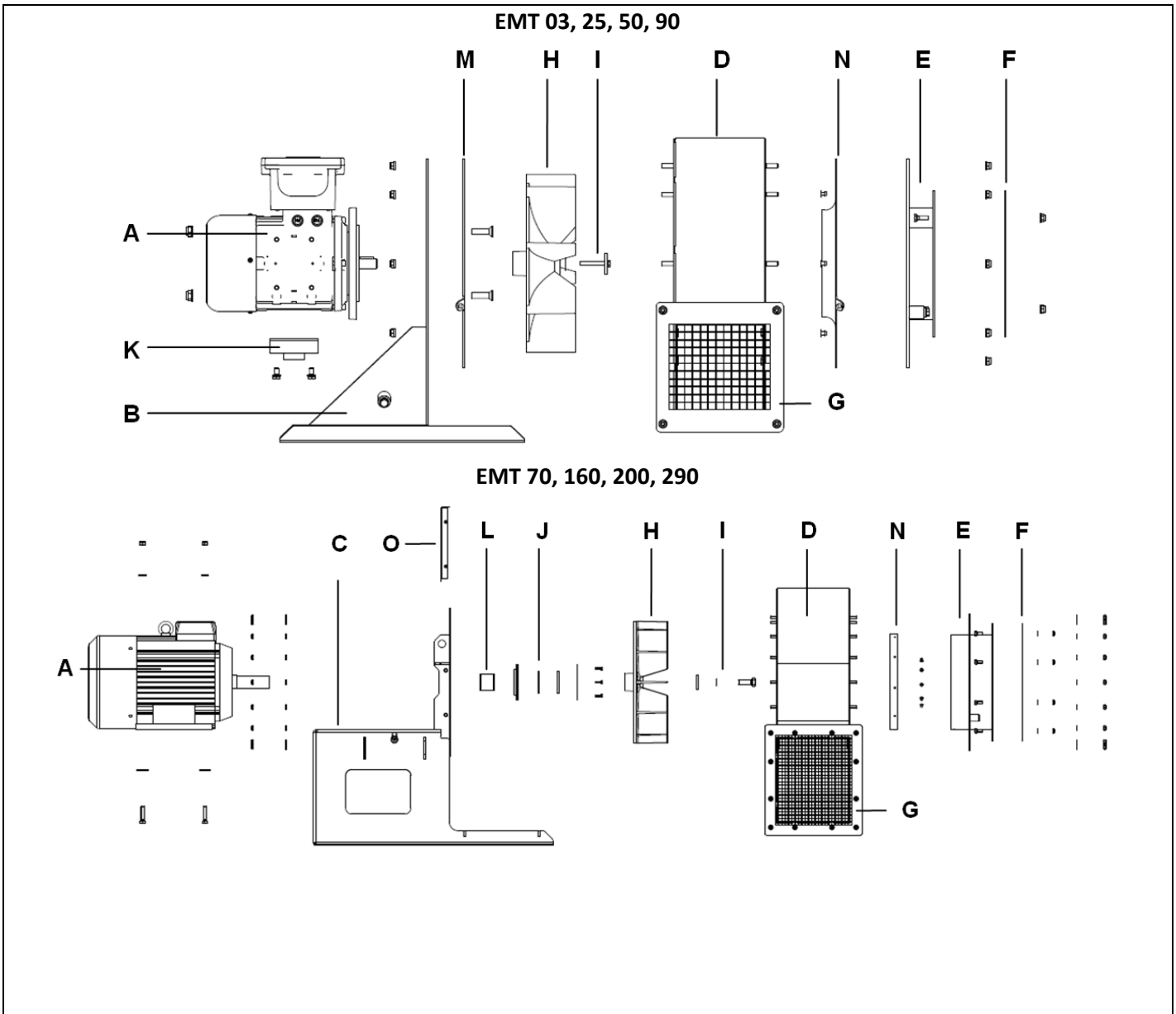

A – electric motor	B – fan stand	C – motor support
D – casing	E – inlet shield	F – inlet protective net
G – outlet protective net	H – impeller	I – impeller lock
J – seal assembly	K – mounting the vibration sensor	L – distance bush
M – motor shield lining	N – inlet lining	O – shaft
P – fasteners ¹		

¹) unselected elements in the drawing

Construction elements (B, C, D, E, K) are made of painted steel. Impeller (H) is made of casting aluminum (2G category) or steel (2D category). Linings (M, N) are made of copper or aluminum. Protective net (F, G) are made of galvanized steel. Bushings and connection elements are made of steel, galvanized steel, stainless steel. Seals are made of plastic.

The full list of elements and materials used in fan construction can be available on a reasonable request.

Appendix - E (Wiring diagrams)

3-phase motors

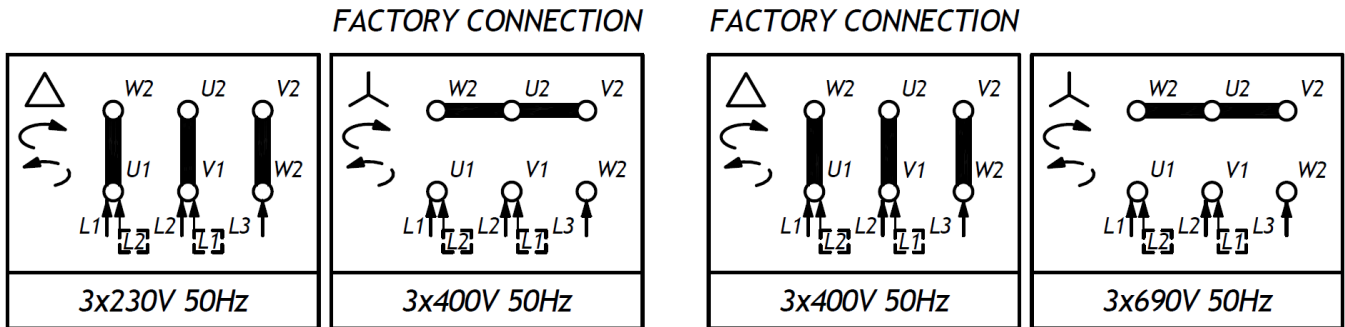

1-phase motors

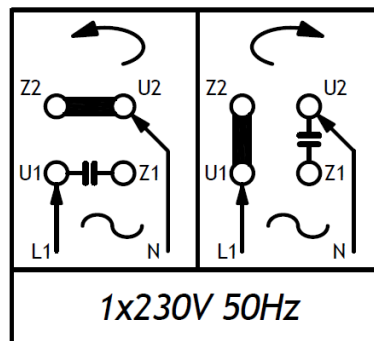

The above diagrams are only a connection guide. The correct wiring diagram for a particular motor model is located under the terminal box cover. The above diagrams do not include sensor connections that may exist in specific device versions.